

Basic Transceiver tests with the 8800SX

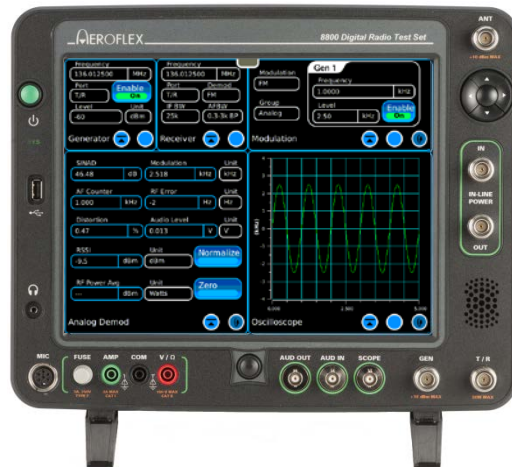

Basic Interconnects

Interconnect 1 – Basic Transmitter/Receiver tests

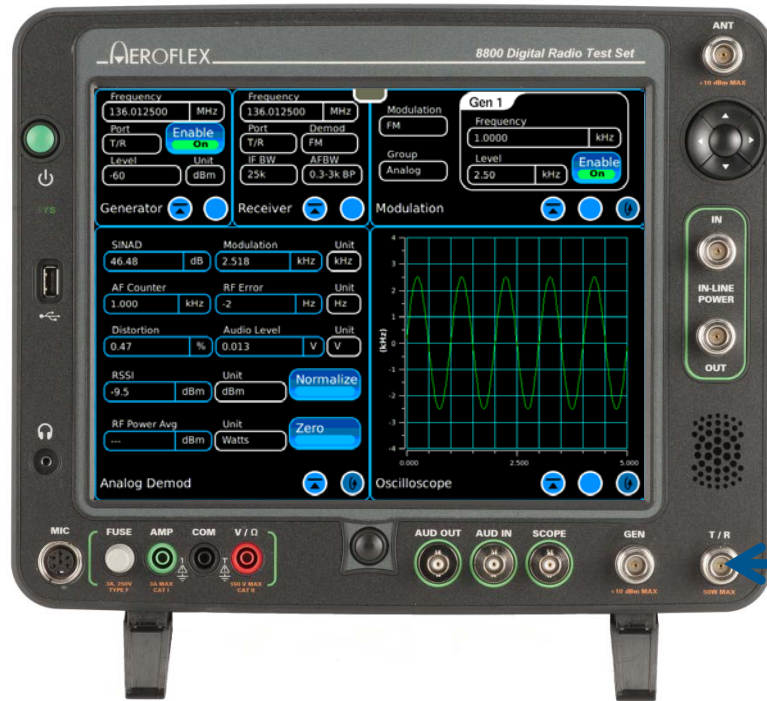

For basic Transmitter and Receiver tests, connect the 8800SX TR port to the Radio ANT port.

RF Test cable

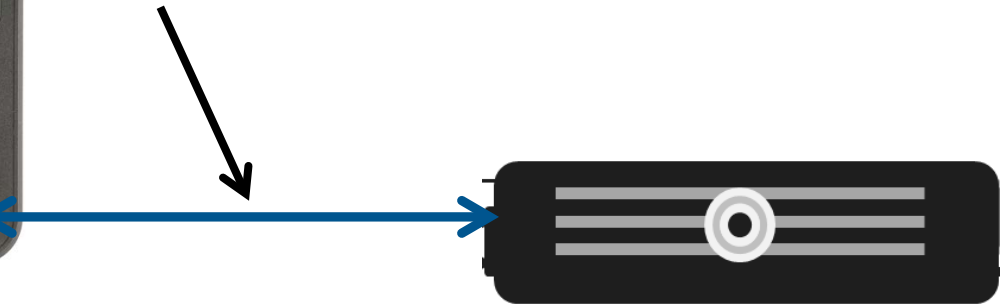

The TR port on the 8800SX is a bi-directional RF port that can generate a signal to test a receiver as well as measure transmitter characteristics like Power, Frequency and Modulation. This port is rated at 50 Watts input. Measurements to 125 Watts are possible observing duty cycle to prevent overheating.

Access to built-in presets

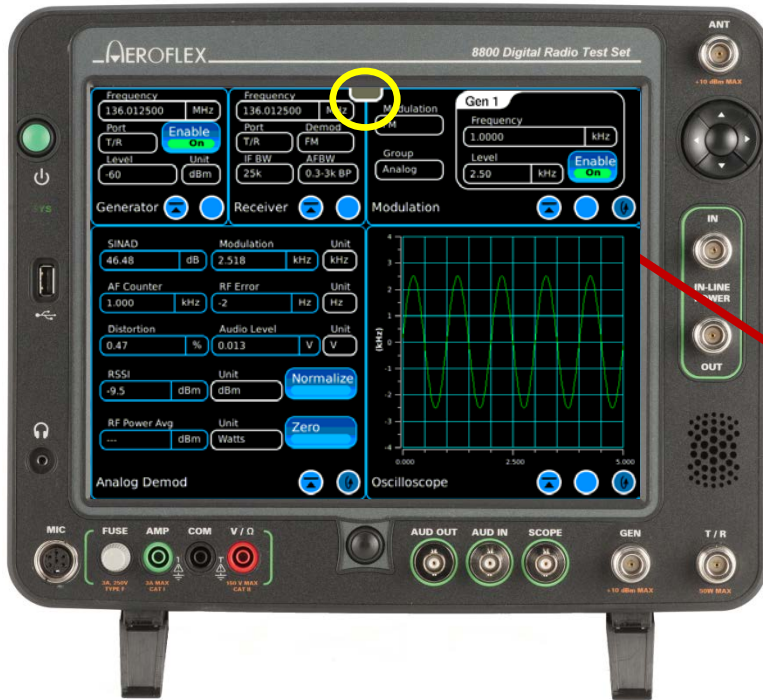

- The small tab at the top center of the display allows access to the launch bar.
- Simply touch the tab and the launch bar will expand.

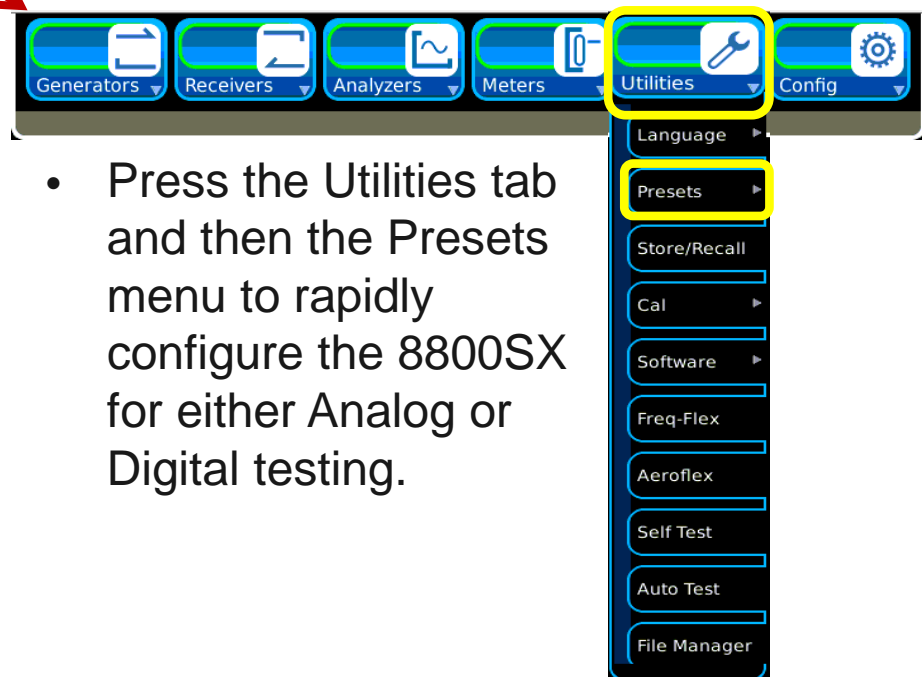

- Press the Utilities tab and then the Presets menu to rapidly configure the 8800SX for either Analog or Digital testing.

Presets quickly configure standard tile selections and locations.

Access to built-in setup files

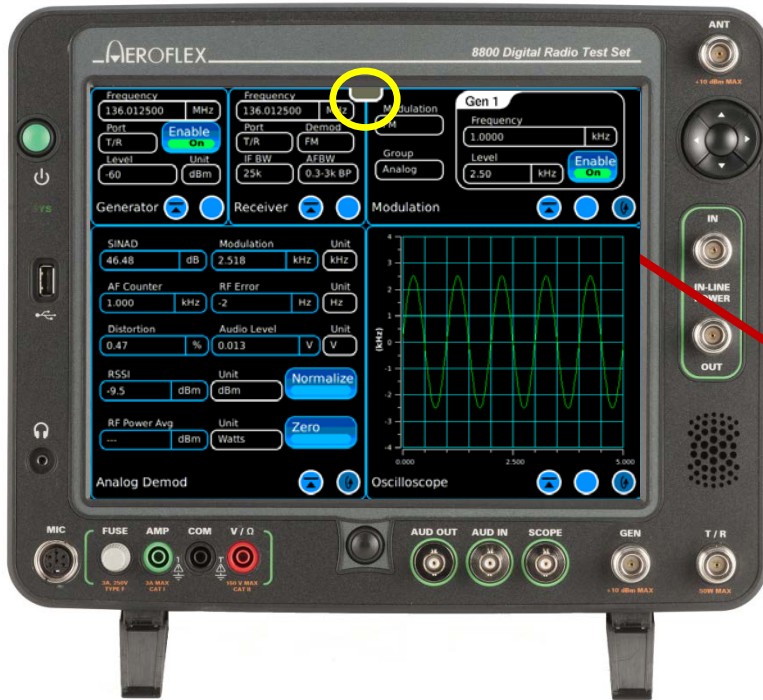



- Setup files store complete instrument configurations that include all settings.
- To open the menu, simply touch the tab and the menu will expand.

Every 8800SX is pre-configured with a large group of sample setups to configure the instrument for a variety of basic tests.

- Press the Utilities tab and then the Store/Recall item to gain access to the pre-configured test setups that are within every instrument.

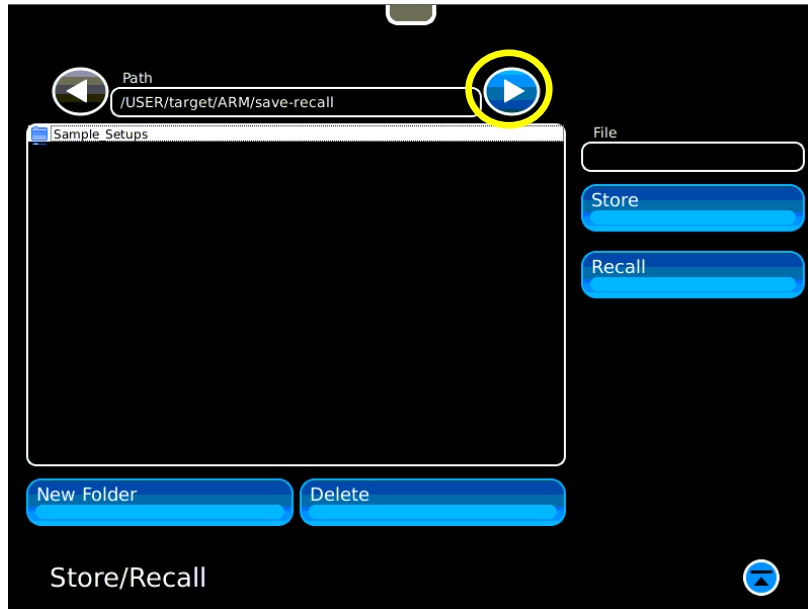
Store/Recall Navigation



- When first entering the Store/Recall menu, a folder named “Sample Setups” will be visible.
- To enter the folder, touch or highlight the Sample Setups item on the list then press the  icon to enter the folder.

The Sample Setups

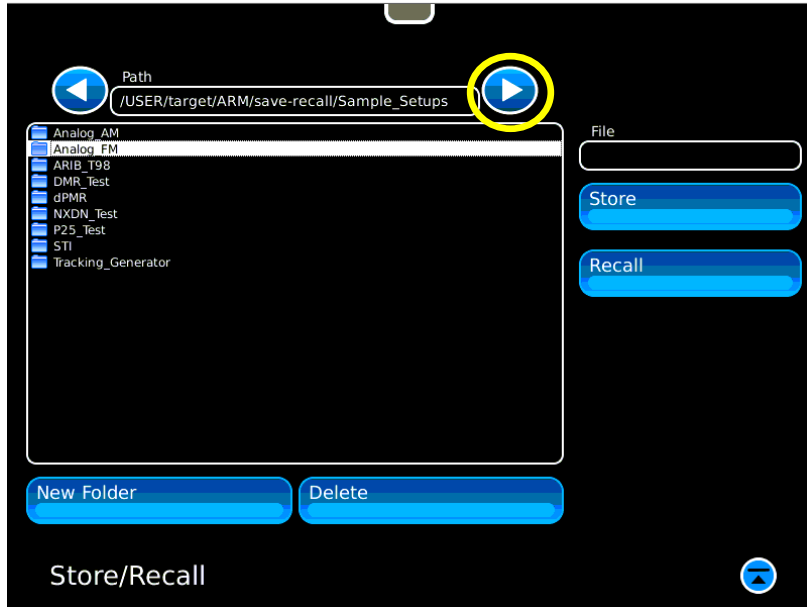

- After entering the Sample Setups folder, there are a variety of basic test folders available.
- This presentation will show some of the ones available for FM and AM transceiver testing.
- Highlight the Analog FM folder and press the  icon to enter the folder.

Configure the 8800SX for FM Transmitter test

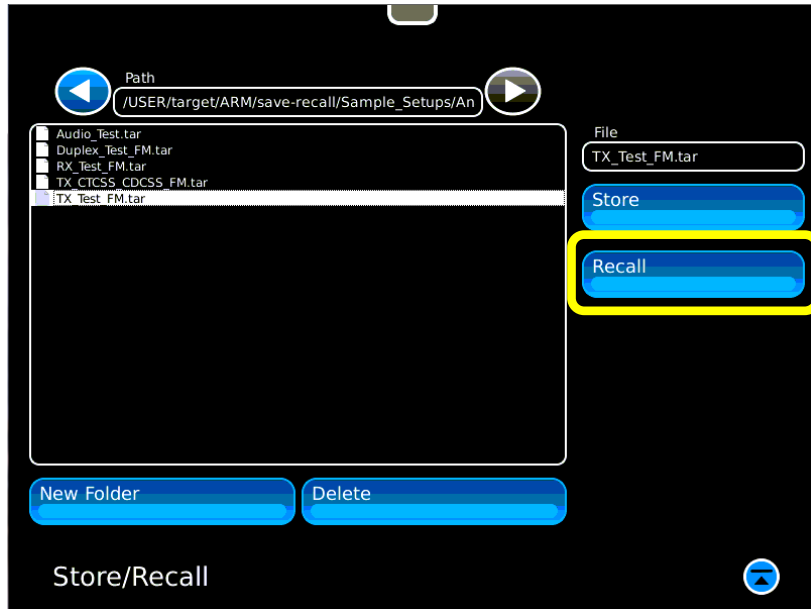

- Highlight the TX_Test_FM setup file and press the Recall button.
- This will configure the 8800SX to perform basic FM transmitter tests.

Measure TX Frequency and Power

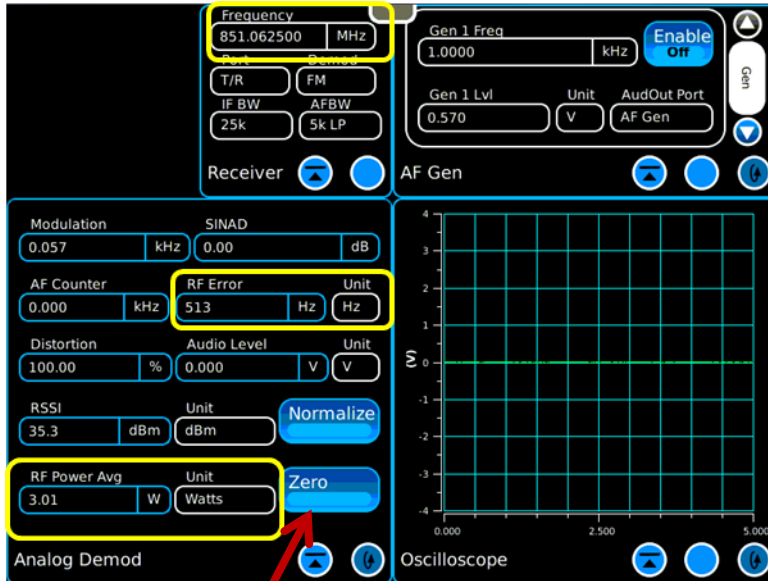

1. Zero the Power Meter.
2. Connect the transmitter as illustrated on slide 1.
3. Enter the transmitter frequency on the Receiver Tile.
4. Key the transmitter.
5. Measure and record the RF Error. This is the transmitter frequency error.
6. Measure and record the RF Power Avg reading. This is the Transmit Power level.

Always Zero the Power Meter before taking power measurements.

Improving the power measurement



- If the loss of the test cable is known, the Power Meter can be compensated by that amount by entering the cable offset value as a negative number on the Expanded Receiver tile.
- After entering this offset, the transmitter output now reads 3.26 watts. This radio had been configured to transmit at 3.2 Watts in this frequency band.

Measure Modulation (Basic Check)

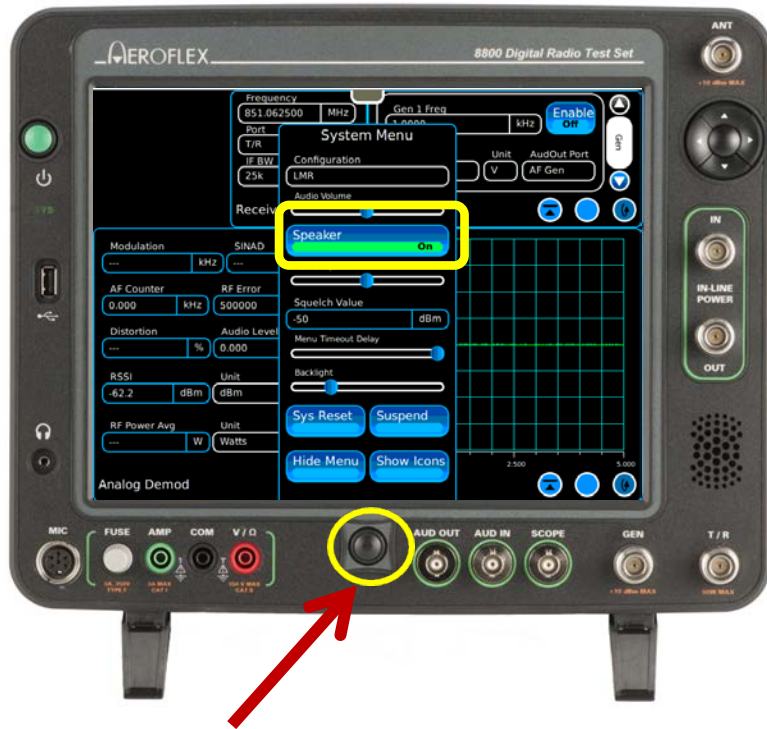



Home Button

A basic transmitter modulation check can be done after making the following changes to the current setup.

1. Press the Home button on the 8800SX front panel.
2. Press the Speaker control to enable the speaker.
3. Press the Home button again to minimize the menu.
4. Note that Audio Volume and Squelch controls are also available on this menu. These may need to be adjusted later as necessary.

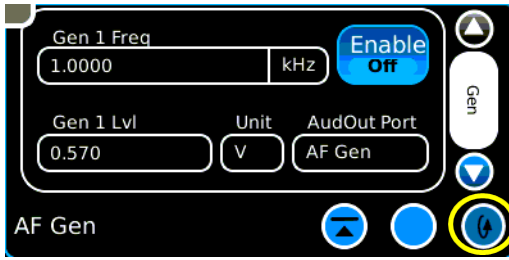
Measure Modulation (Basic Check)



- On the AF Gen tile, press the Fast Stack  icon until the Audio Config Tile is revealed.
- Press the  icon on the Audio Config Tile to reveal the audio signal routing table.
- Establish the following routings:

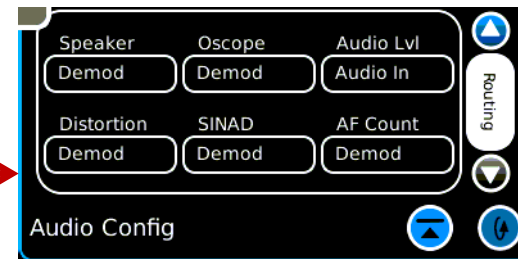
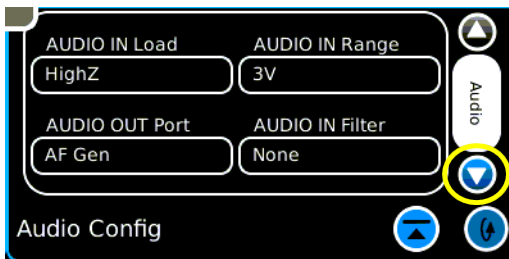
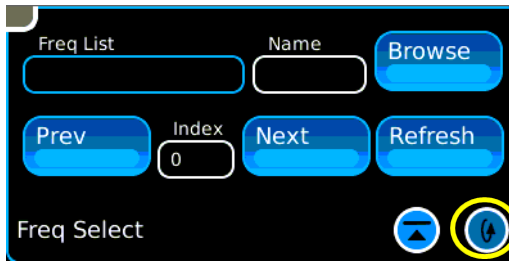

Measure Modulation (Basic Check)

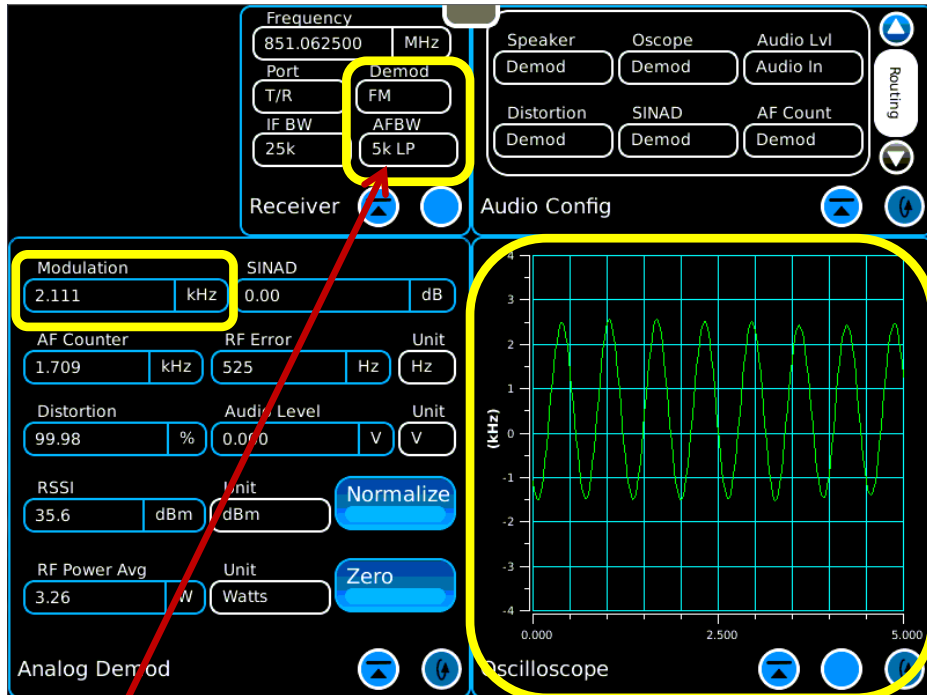

- Key the transmitter under test and speak into the radio microphone.
- Audio should be heard in the 8800SX speaker.
- Voice modulation should be visible on the Oscilloscope.
- Modulation value should be visible on the Modulation Meter.
- For AM Modulation testing, change the Demod value on the Receiver Tile from FM to AM.

To measure sub-audible tones, set the AFBW value to 300 Hz LP to filter out audio signals above 300 Hz.

Measure Modulation (Advanced Check)

- To externally modulate the transmitter with a tone, connect the 8800SX Audio Out Port to the radio's Microphone input.
- The AF Gen Tile can then be used to apply a tone to modulate the transmitter.
- Additional testing of Transmitter distortion and microphone sensitivity can now be performed.

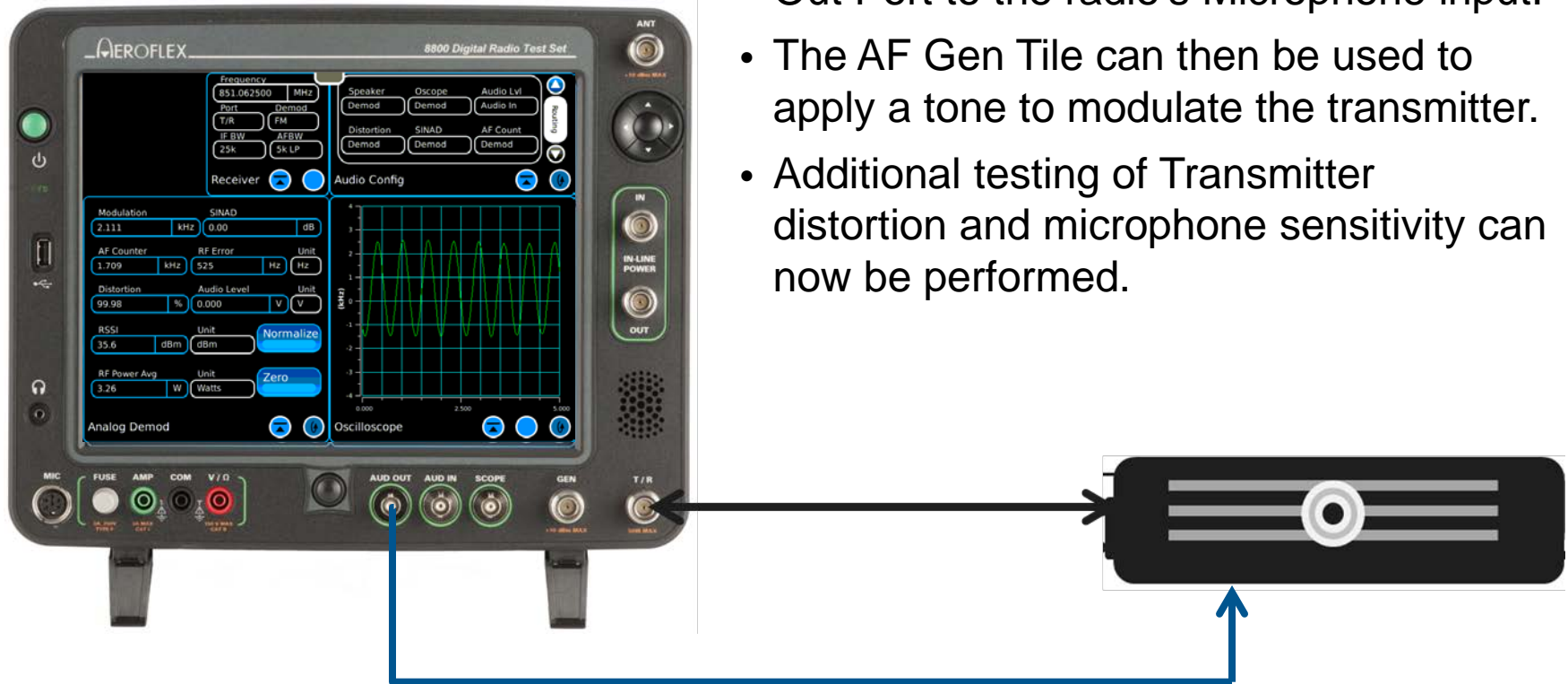

Measure Modulation (Advanced Check)

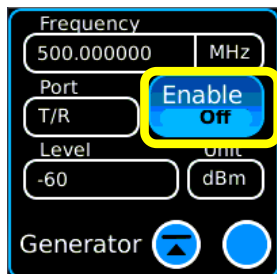
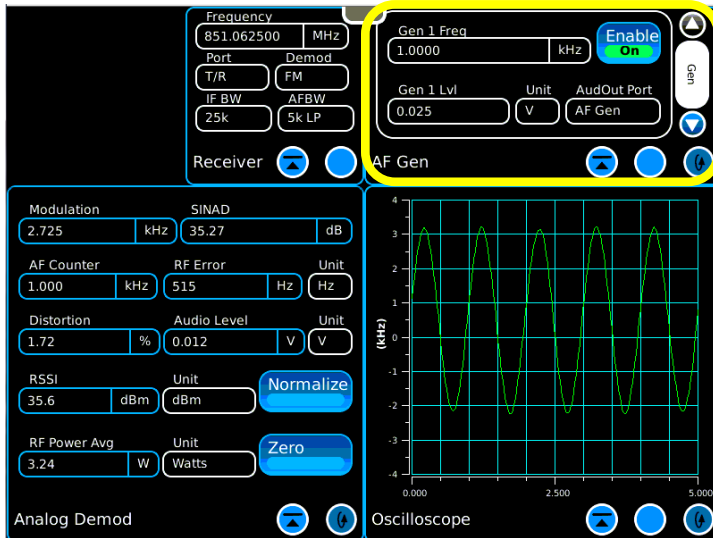

- With the radio keyed and connected as shown in the previous slide, additional measurements can be made.
- Enable the AF Gen and adjust the AF Gen Level to achieve the desired modulation results.
- Measure the transmitter distortion.
- Turn the AF Generator OFF when testing is complete.
- Note: The RF Generator must not be enabled when doing this test.

Additional signaling formats

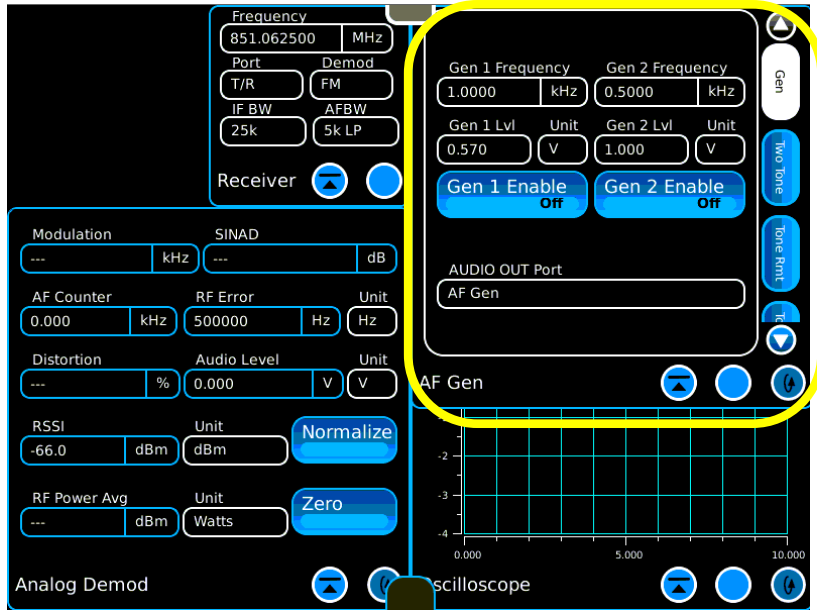

- Expanding the AF Generator Tile reveals a number of other signaling formats that can be used instead of a steady state tone.
- The tabs on the side can be used to access:
 - Two Tone
 - Tone Remote
 - Tone Sequential
- Each selection will reconfigure the tile for the selected operation.

Basic Receiver Test

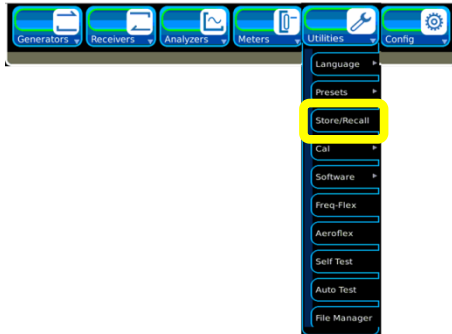

- To test the radio receiver, recall the RX_Test_FM setup file from the Store/Recall screen from the Utilities – Store/Recall menu.
- Select the sample setup RX_Test_FM setup file and press the Recall button.

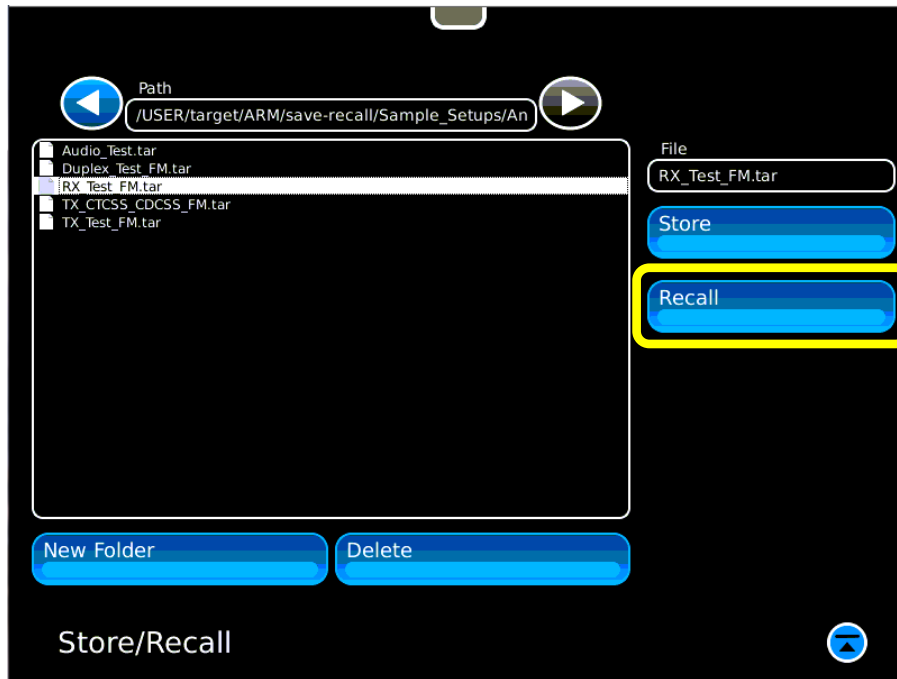

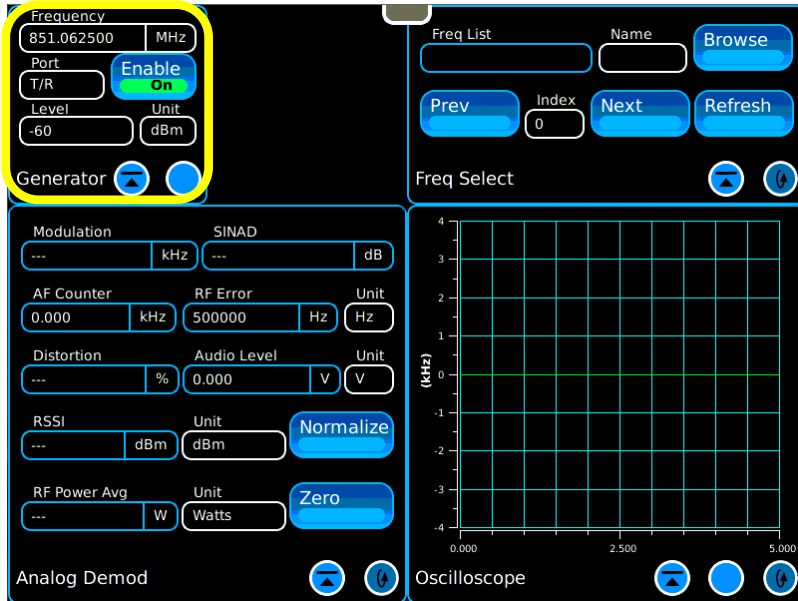

Basic Receiver Test

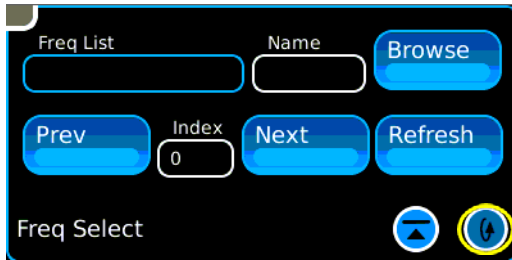

- On the Generator Tile, enter the radio's receive frequency in the Frequency entry field.
- Enable the RF Generator (On).

Basic Receiver Test



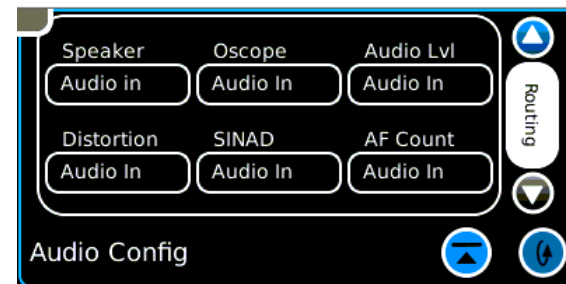

- On the Freq Select Tile, press the Fast Stack  icon until the Audio Config Tile is revealed.
- Press the  icon on the Audio Config Tile to reveal the audio signal routing table.
- Establish the following routings:

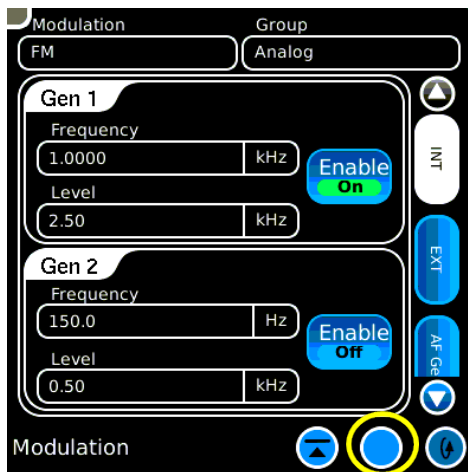
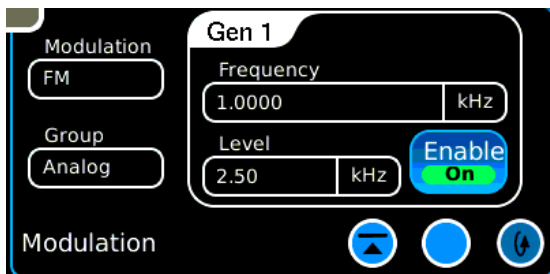

Basic Receiver Test



- On the Audio Config Tile, select the Fast Stack  icon to reveal the Modulation Tile.
- The default setting for this setup is modulation at a 1 kHz rate at 2.5 kHz deviation. Both values may be modified as necessary.
- Pressing the Expand  icon reveals a second modulator that may be used in addition to the first. The two tones will be summed and applied to the generator modulator.
- Audio should now be heard from the receiver under test. The radio's volume and squelch settings may need to be adjusted.

Basic Receiver Test

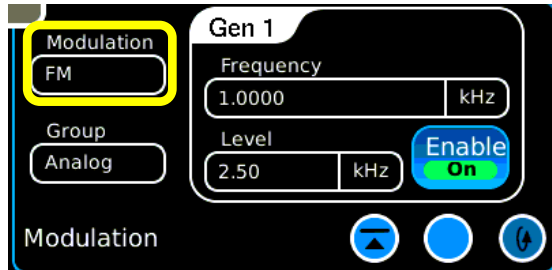

- For AM Receiver testing, change the Modulation mode from FM to AM on the Modulation Tile.

Advanced Receiver Testing

- Connect the 8800SX Audio In port to the radios SPKR output.
- Adjust the receiver volume output to the desired level as indicated by the 8800SX Audio Level Meter then measure receiver distortion of the radio.
- Note that the Modulation Frequency must be at 1 kHz rate for Distortion and SINAD measurements.

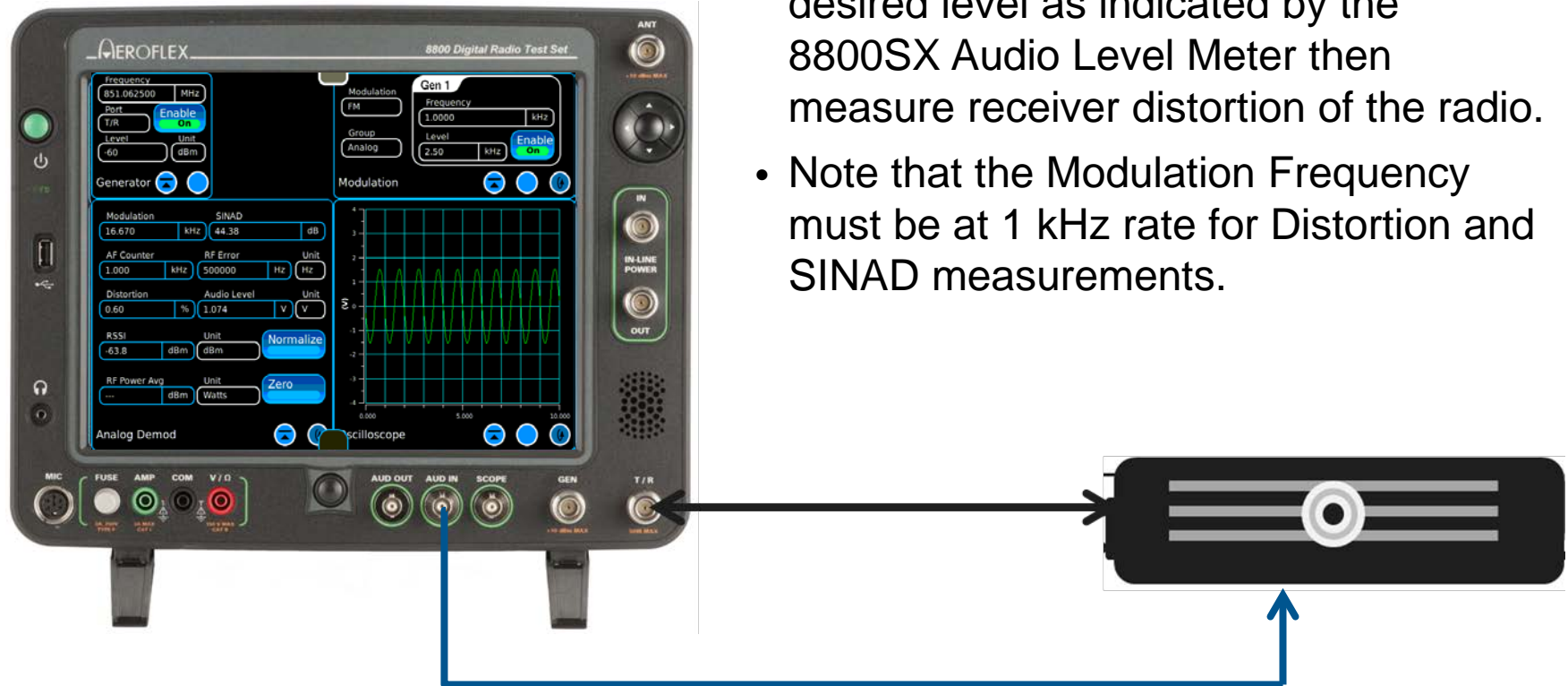

Advanced Receiver Testing

- Using the up and down arrow controls, the RF Generator level can be adjusted to obtain a desired SINAD level to evaluate receiver sensitivity.

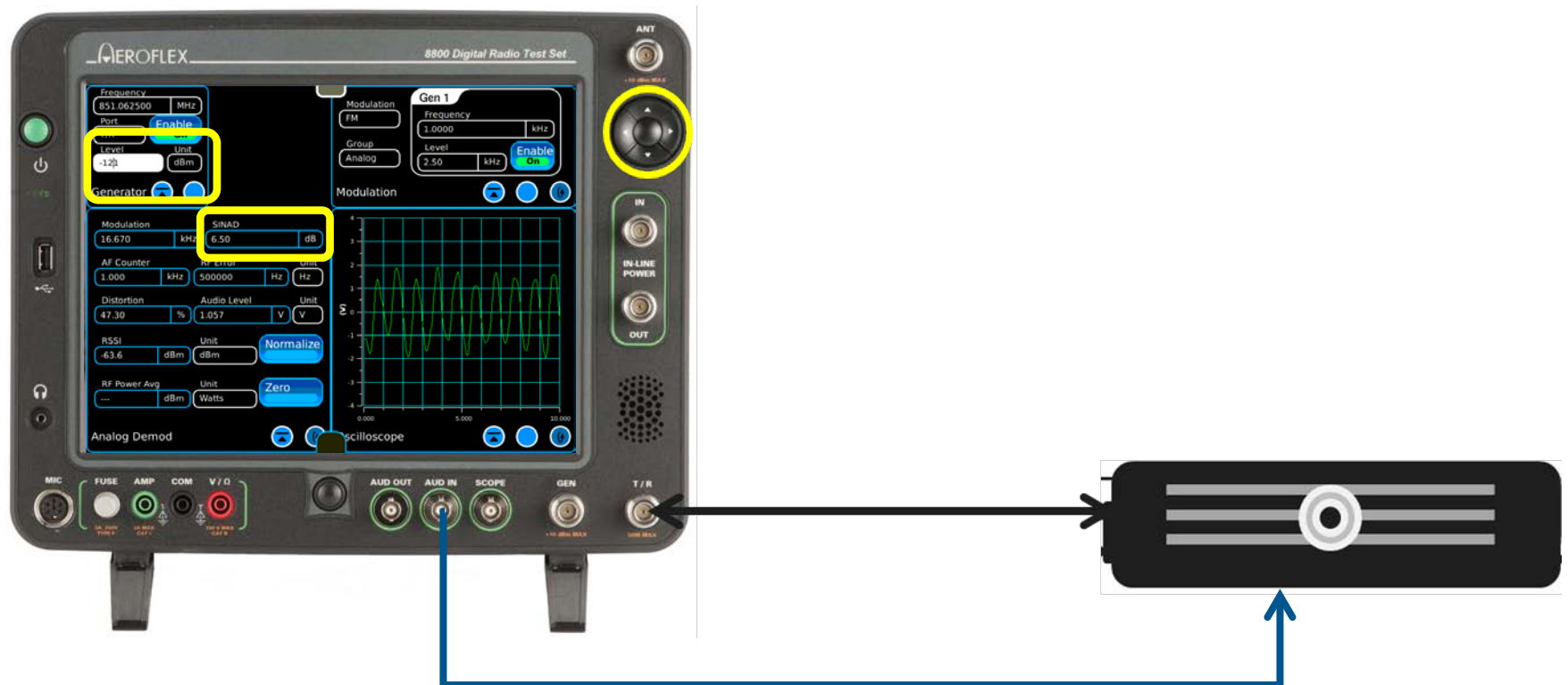

Radio and Antenna Testing

- From the meters tab on the launch bar, choose the Inline Power Meter.

- Antenna tests can be done by connecting the transmitter output to the In-Line Power Meter IN Port.
- The radio's Antenna can be connected to the Out Port of the In-Line Power Meter.

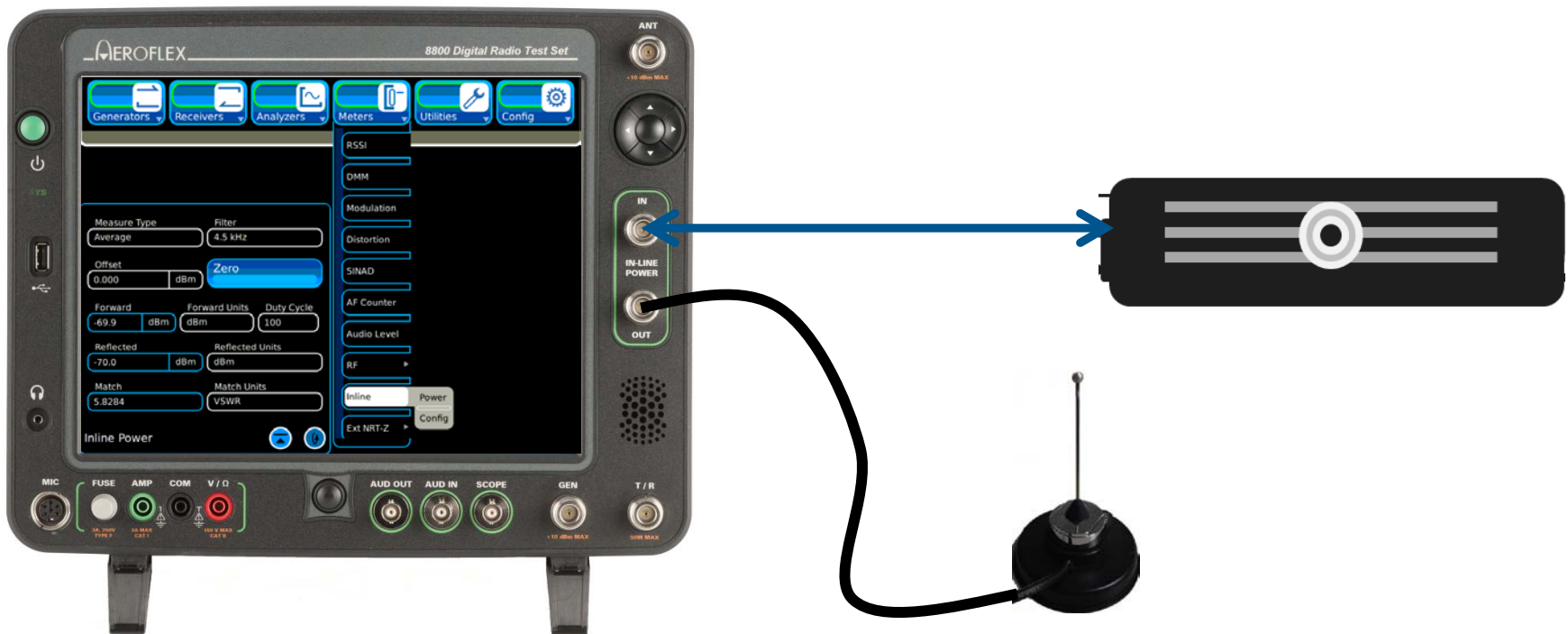

Radio and Antenna Testing

Matched antenna VSWR and Return Loss



- Zero the Power Meter prior to taking measurements.
- The Antenna match can be viewed as VSWR or Return Loss.
- An antenna that is tuned to the transmit frequency will show a high RTL and a low VSWR.

Mismatched antenna VSWR and Return Loss

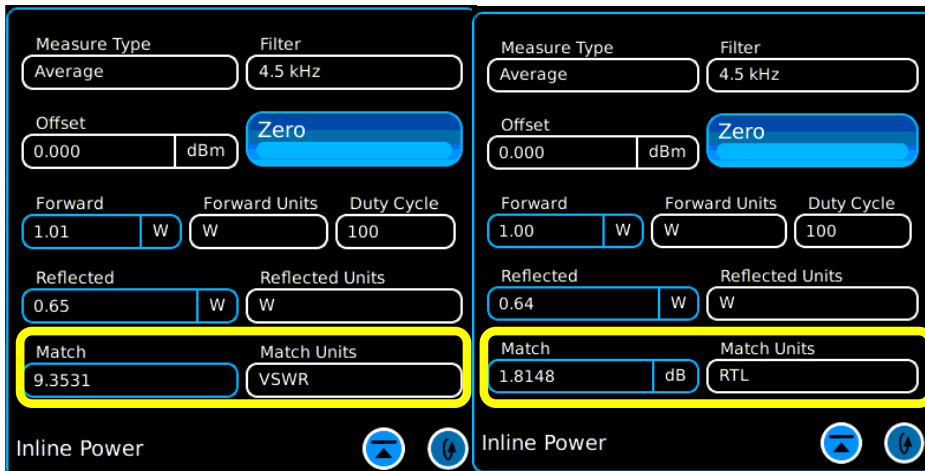

In-Line Power Measurements

The screenshot displays a control panel for power measurements. The 'Offset' field is highlighted with a yellow border and contains the value '0.000' with 'dBm' units. Other fields include 'Measure Type' (Average), 'Filter' (4.5 kHz), 'Forward' (2.97 W), 'Forward Units' (W), 'Duty Cycle' (100), 'Reflected' (0.01 W), 'Reflected Units' (W), 'Match' (1.1463), and 'Match Units' (VSWR). The text 'Inline Power' is visible at the bottom left, and there are two circular icons at the bottom right.

Measure Type	Average	Filter	4.5 kHz
Offset	0.000 dBm	Zero	
Forward	2.97 W	Forward Units	W
Duty Cycle	100		
Reflected	0.01 W	Reflected Units	W
Match	1.1463	Match Units	VSWR

- In addition to VSWR match, Forward and Reflected power can be measured.
- An Offset entry allows for a test cable correction factor to be entered if a test cable is being connected directly to a transmitter. The entry assumes a negative value.

Over the Air Interconnect

- The 8800SX can be configured to talk over the air to simulate a radio transmitter and receiver.
- When the 8800SX Microphone PTT is keyed, the 8800SX will generate a signal and speaking into the microphone can be heard on the receiver under test.
- Using a microphone on the transmitter under test, voice communications to the 8800SX is possible.

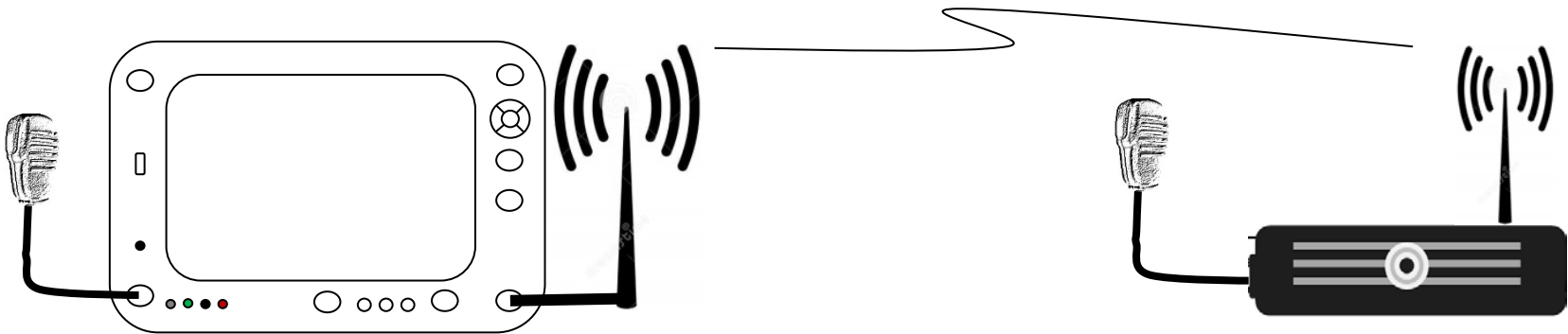

Connect an antenna to the 8800SX T/R Port and the Radio ANT Port.

Over the Air Testing

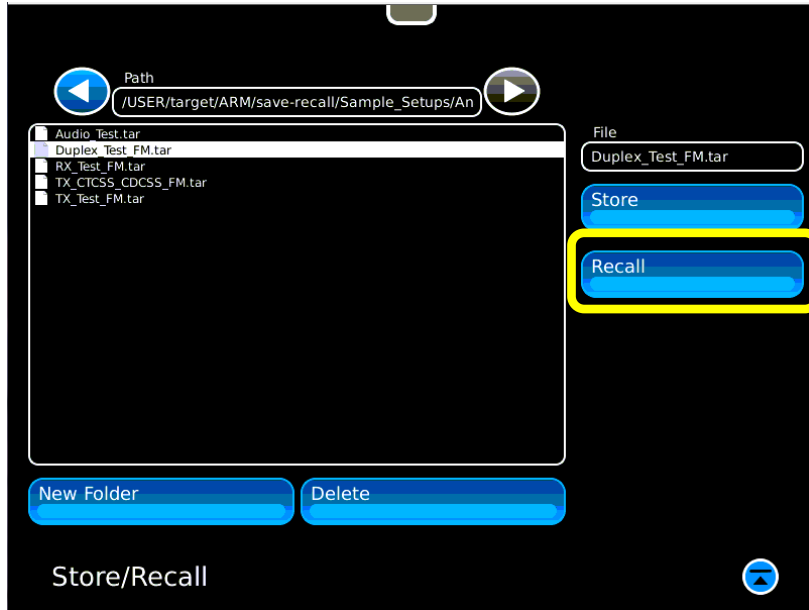

- For this test, recall Duplex_Test_FM setup file from the Sample Setups.
- Connect a Microphone to the 8800SX MIC jack.

Configure the 8800SX for Over the Air

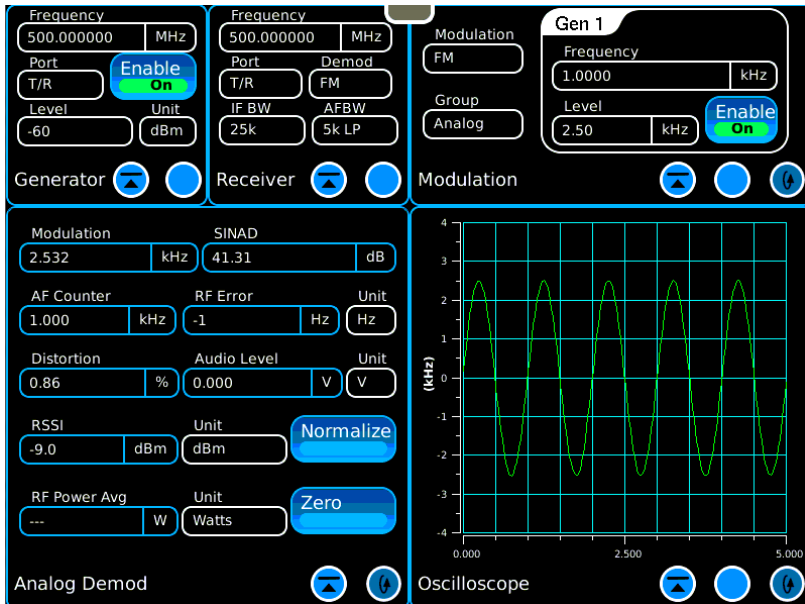

- The initial conditions after recalling this setup will need to be modified for the test.
- The setup file configures the input and output ports to the T/R. This allows the 8800SX to see its own signal.

Enable the 8800SX Speaker

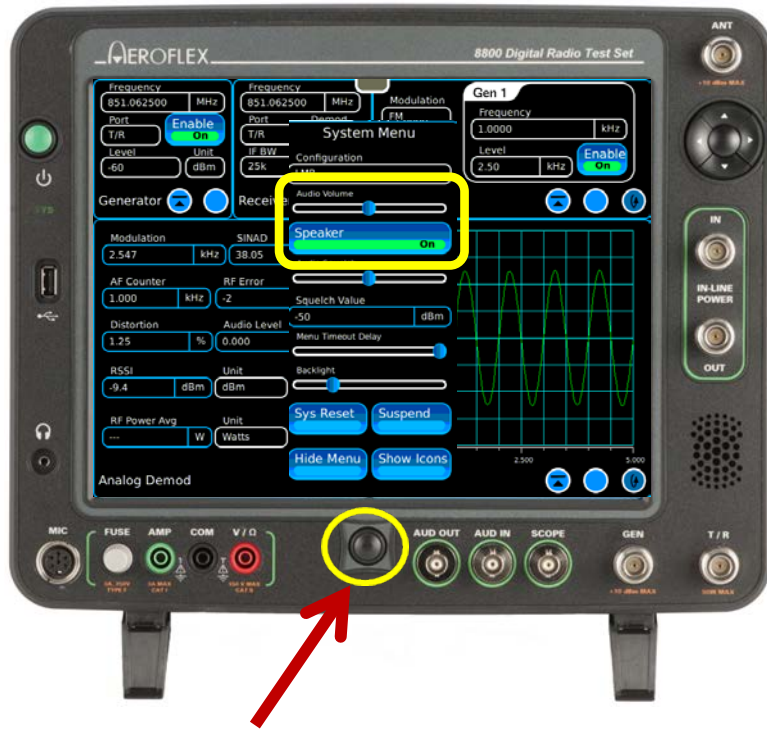

Home Button

- Press the Home Button and Enable the speaker.
- Adjust the volume to mid range.
- Adjust the Squelch to mid range.
- Press the Home button to close the menu.

Communicate with the Receiver Under Test

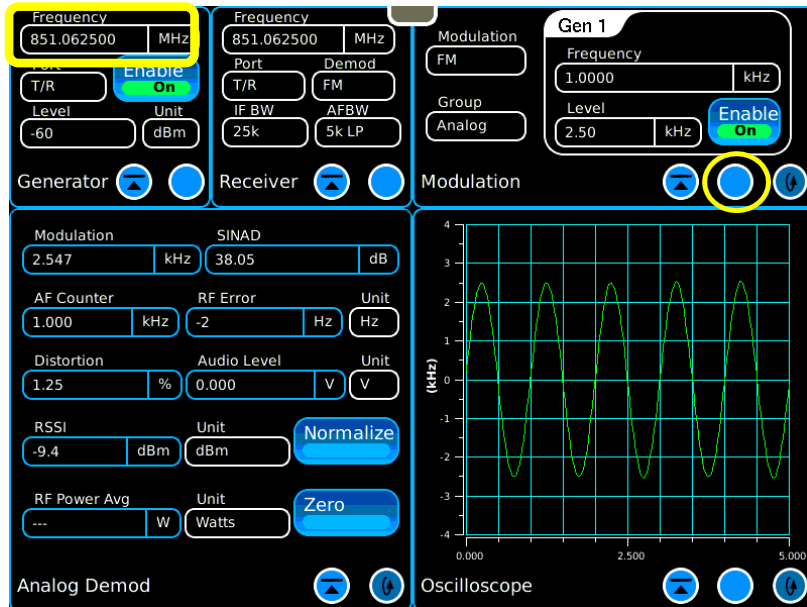

1. On the 8800SX Generate Tile, enter the radio's Receive frequency.
2. A 1 kHz tone should now be heard from the receiver under test.
3. Depress and release the 8800SX PTT button on the microphone.
4. The 8800SX will now only generate when the microphone PTT button is depressed.
5. To use voice instead of tone, turn Gen 1 OFF select EXT after expanding the Modulation Tile.

6. Select the EXT tab and enter a desired modulation level for the MIC to use voice modulation.

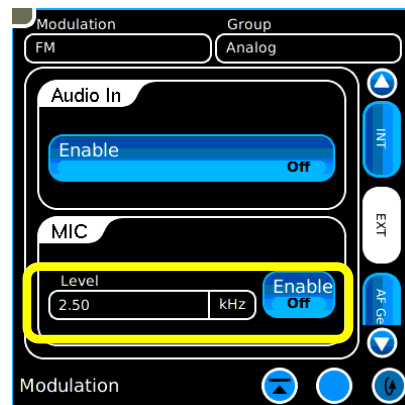

Communicate with the Transmitter Under Test

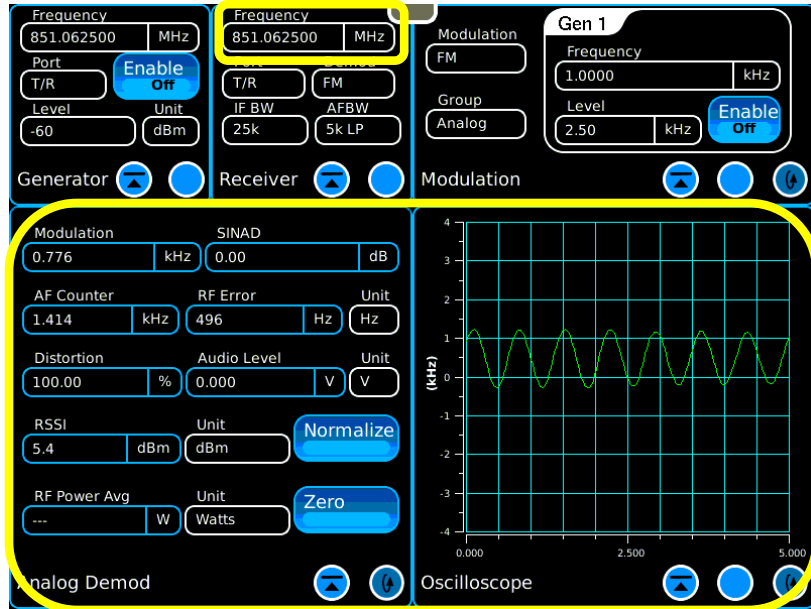

- On the 8800SX Receiver Tile, enter the UUT Transmitter frequency.
- Key the transmitter under test and speak into the radio's microphone.
- You should hear voice on the 8800SX speaker now.

- The 8800SX Analog Demod panel now shows Transmitter Frequency Error, Modulation and signal strength with the RSSI meter.
- If desired, a Channel Analyzer can be added to the display from the Analyzers Tab on the launch bar.

Tone Signaling

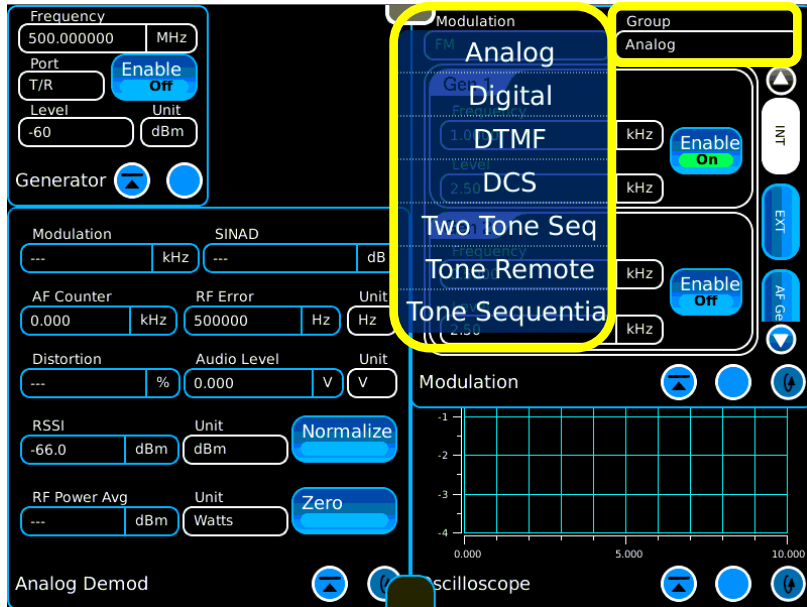

- In addition to tones and voice, a variety of signaling options are available on the Modulation Tile.
- On the Modulation Tile, select the Group field to view a variety of other tone formats to choose from.
- Each selection will populate the Modulation Tile with the associated controls for the item selected.

Basic Repeater Testing

Interconnect 1 with Option 12 Internal Precision Power Meter

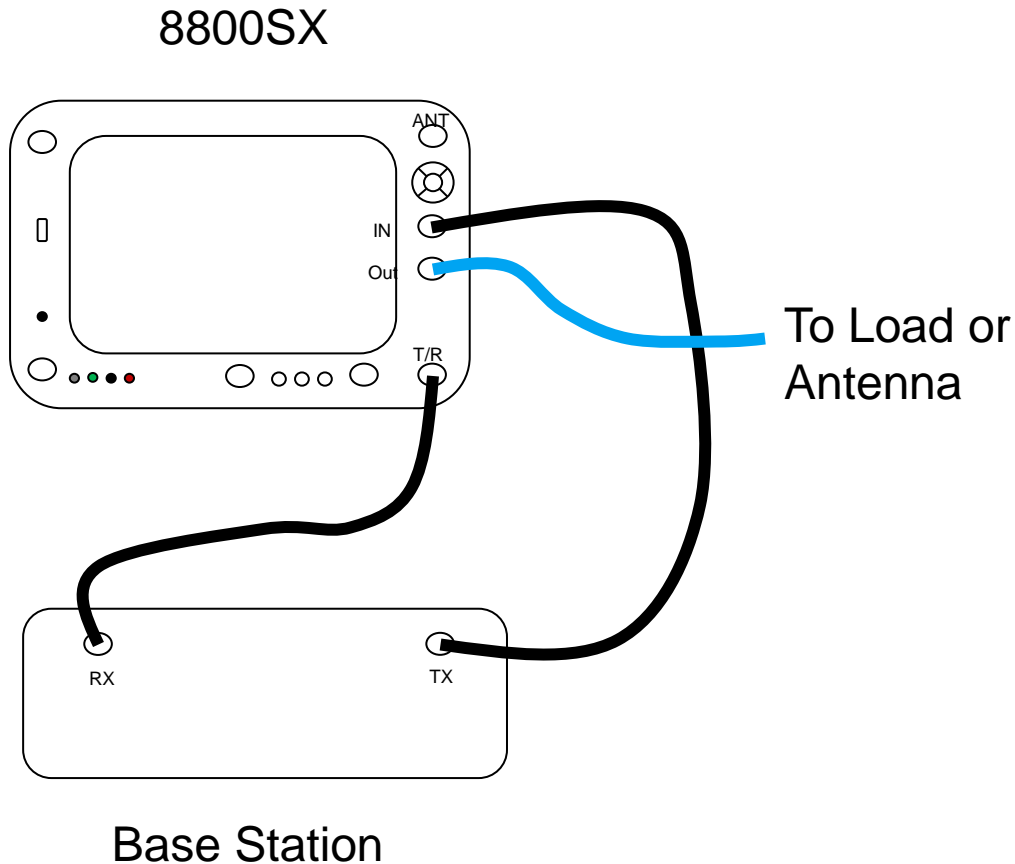

- The 8800SX can generate a signal level down to -125 dBm from the T/R Port to test base station RX sensitivity.
- The base station Transmit can be connected to the IN Port of the Inline Power Meter.
- The Out Port of the Inline Power Meter can be connected to a suitable load or antenna.

Basic Repeater Testing

Interconnect 2 with External 40 dB Attenuator

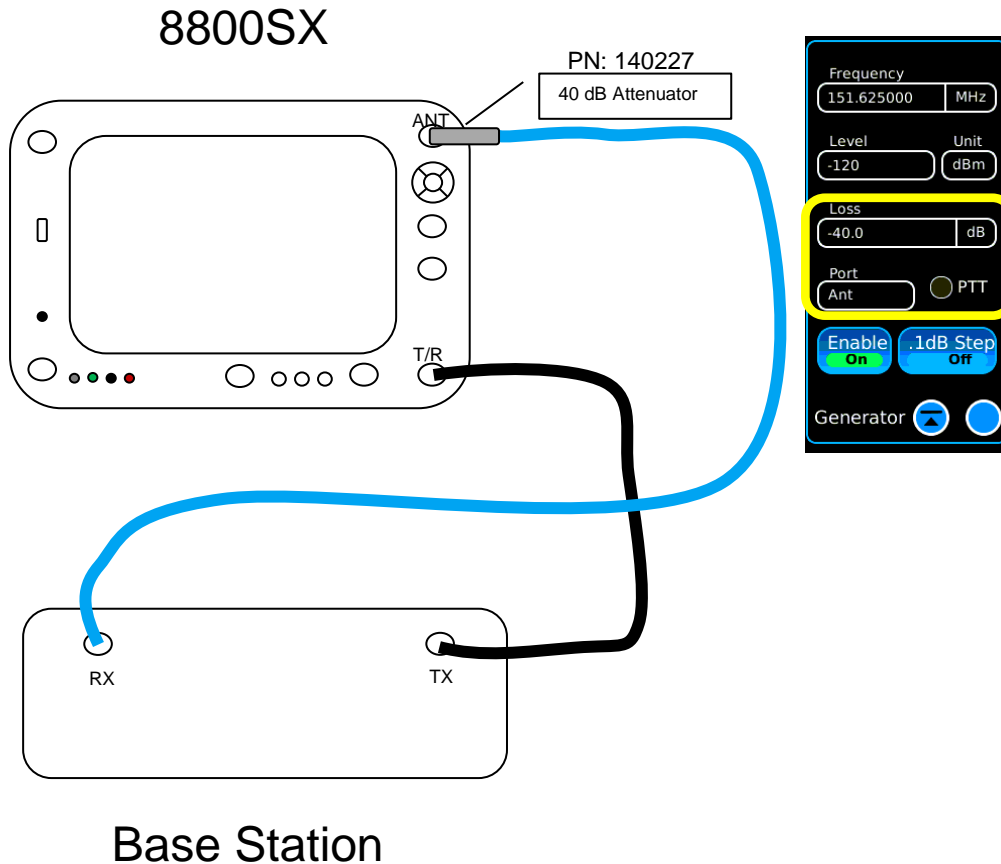

- The 8800SX can generate a signal down to -90 dBm from its ANT Port.
- The addition of an external 40 dB attenuator allows output levels down to -130 dBm to test the base station RX Sensitivity.
- Select the ANT Port on the Generator Tile.
- Enter -40 dB on the Generator Tile Offset value.

Basic Repeater Testing

Interconnect 3 Interface to BS/Repeater Duplexer

8800SX

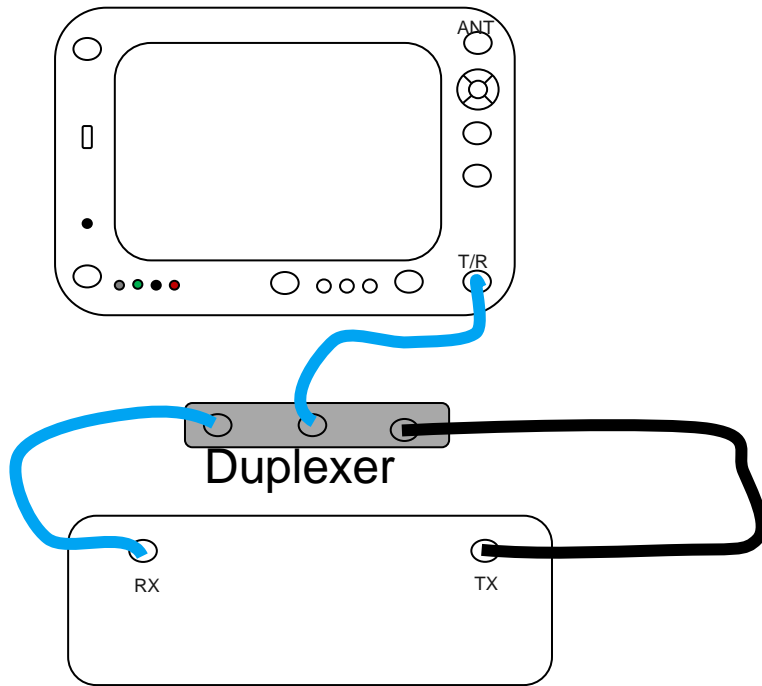

Base Station

- The 8800SX connected to a duplexer through a single port connection.
- Connect the 8800SX TR Port to the Duplexer ANT Port.
- With this connection the 8800SX can generate to the Repeater RX while simultaneously receiving the Repeater TX while connected to the 8800SX TR Port.

Frequency List

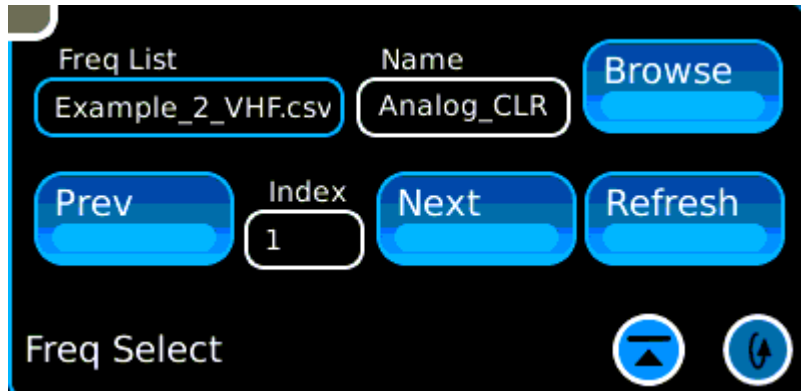

- The 8800SX offers a very useful feature to maintain user programmed frequency lists to speed testing.
- From the launch bar choose Receiver > Freq Select.
- This tile allows you to select a stored frequency list that includes an optional name for each frequency pair in the list.
- Simply use the “Prev” and “Next” buttons to step through the programmed frequencies.

Frequency List Configuration

Access the Frequency List from the Config menu by selecting Freq List.

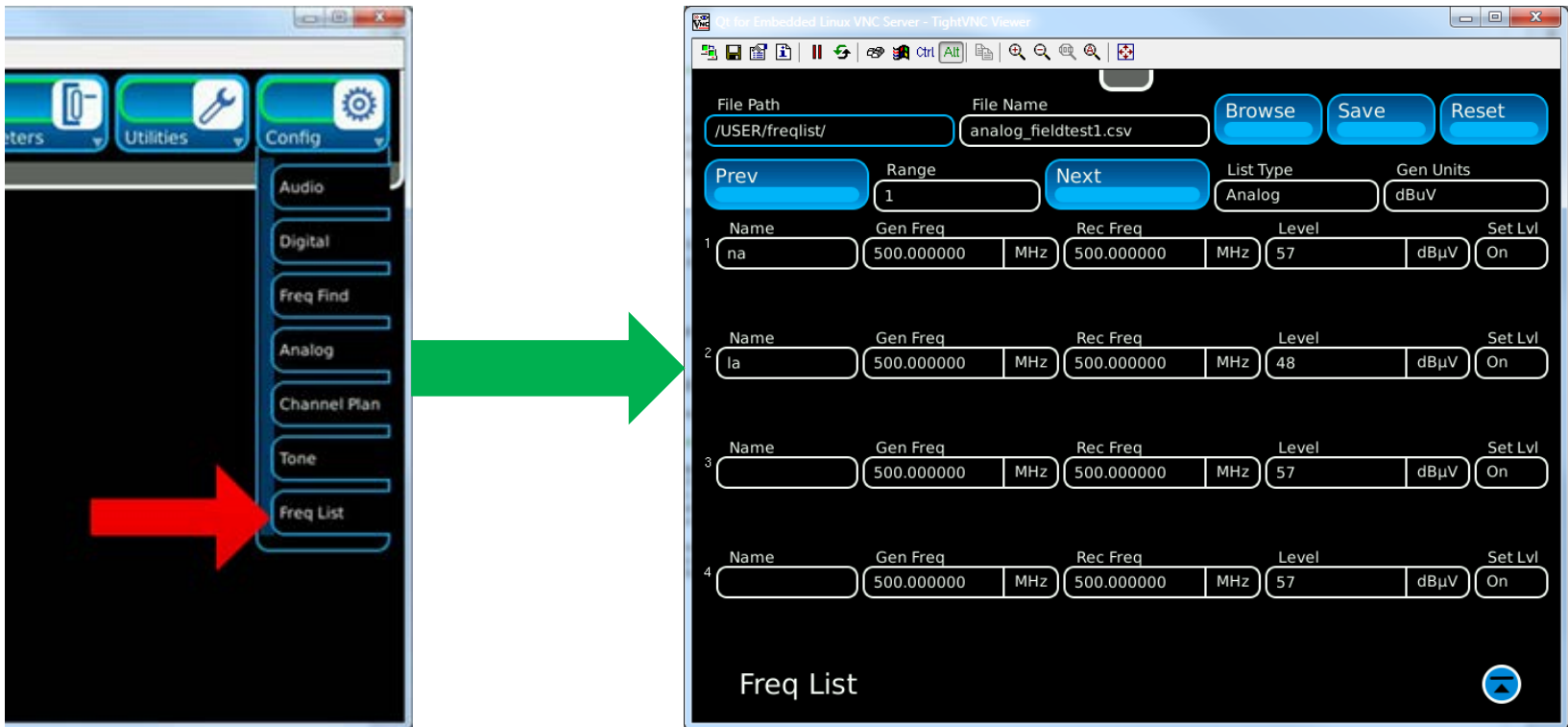

Antenna Testing with the Tracking Generator

Requires the Precision DTF/VSWR kit and Tracking Generator

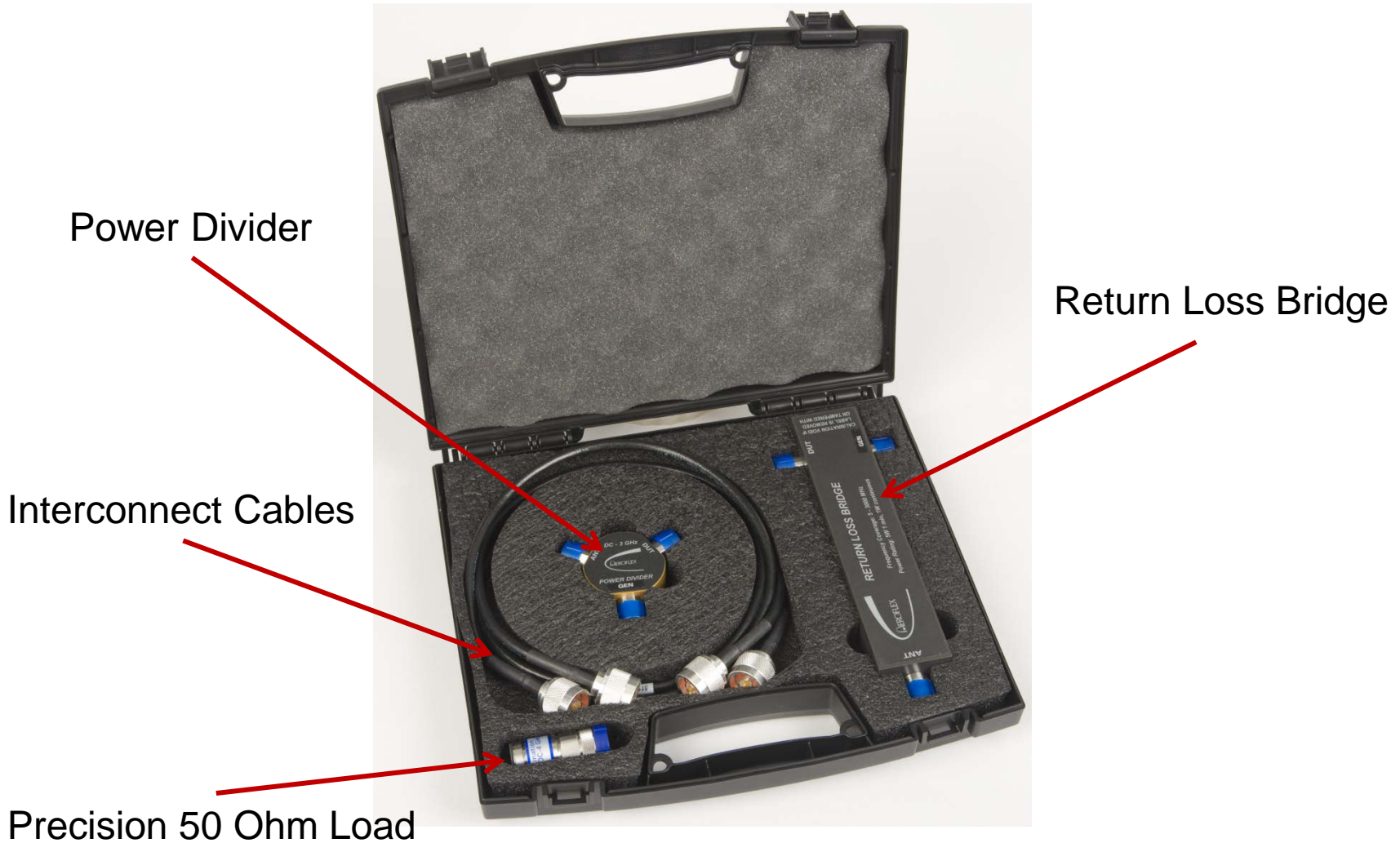

Return Loss Bridge Hookup



With the optional Soft-Sided Carrying Case, the Return Loss Bridge can be mounted for quick and easy access. Simply connect the provided N Type cables from the 8800SX to the Return Loss Bridge.

1. Connect the Bridge “GEN” Port to the 8800SX “GEN” Port.
2. Connect the Bridge “ANT” Port to the 8800SX “ANT” Port.



With the Return Loss Bridge you can measure Antenna or Device Return Loss or VSWR.

Use the Power Divider to measure Distance to Fault.

Accessing the Tracking Generator Screen

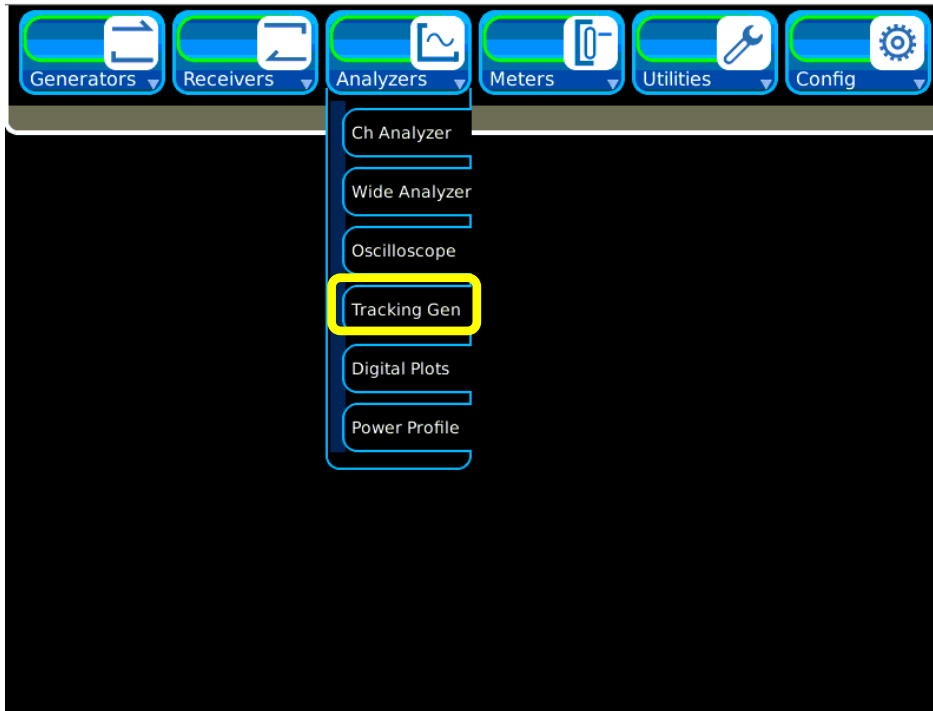

- VSWR, Return Loss plots and Distance to Fault measurements are done using the Tracking Generator mode.
- To access the Tracking Generator, select Tracking Gen from the Analyzers tab on the launch bar.

Configure for Return Loss/VSWR Sweep

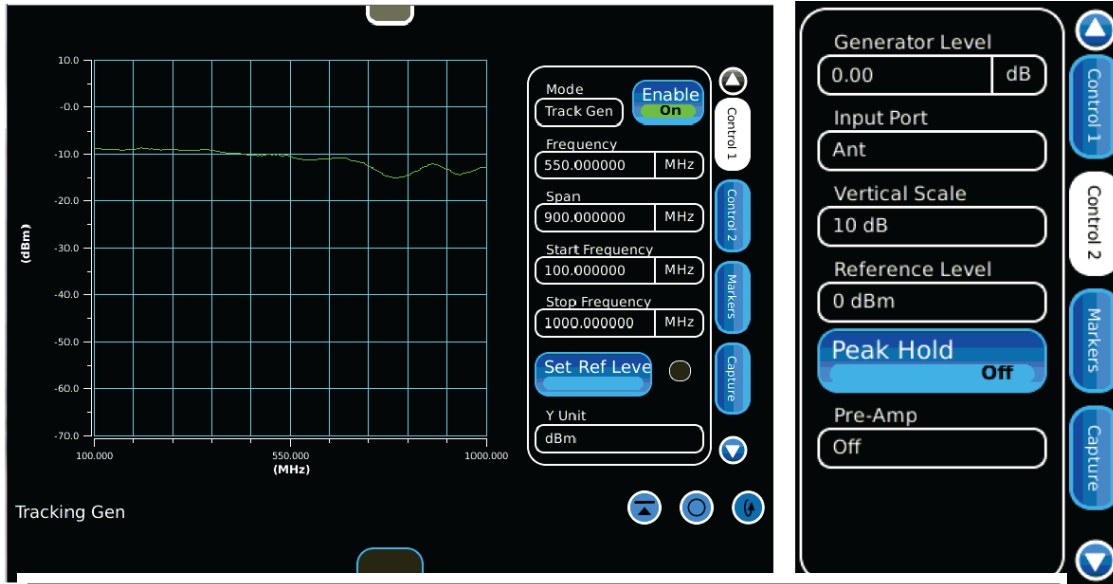

- Connect the Return Loss Bridge as indicated earlier.
- Establish the settings as indicated in the chart for Control Tab 1 and Control Tab 2.
- On Control Tab 1, press the “Set Ref Level” button to establish a zero reference.

Control 1	Setting	Control 2	Setting
Mode Enable	Track Gen ON	Generator Level	0 dB
Center Frequency	N/A	Input Port	ANT
Span	N/A	Vertical Scale	10 dB
Start Frequency	100 MHz	Ref Level	0 dBm
Stop Frequency	1 GHz	Peak Hold	Disabled
Set Ref Level		Pre-Amp	OFF
Y Unit	dBm		

VSWR Sweep

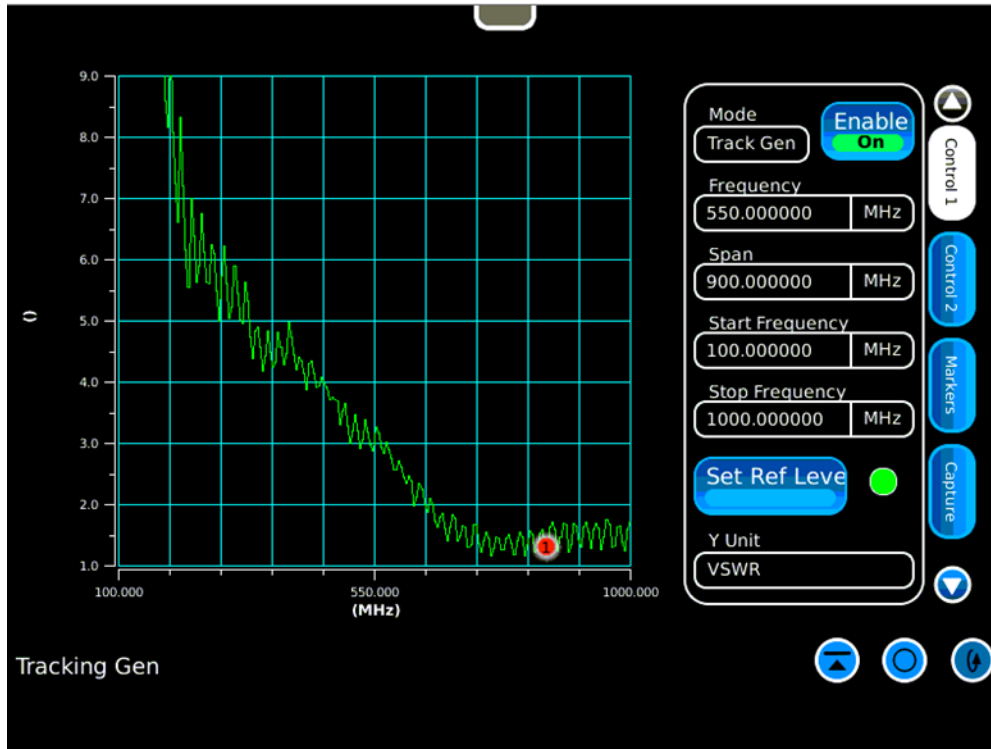

- Connect an antenna or device to the Return Loss Bridge “DUT” (Device under test) Port.
- As configured, this will show a sweep from 100 MHz to 1 GHz.
- Set Y Unit to VSWR on Control Tab 1.
- This VSWR sweep shows good performance at higher frequencies.

Power Divider Hookup



With the optional Soft-Sided Carrying Case, the Power Divider can be mounted for quick and easy access. Simply connect the provided N Type cables from the 8800SX to the Power Divider.

1. Connect the Divider “GEN” Port to the 8800SX “GEN” Port.
2. Connect the Divider “ANT” Port to the 8800SX “ANT” Port.

Measuring DTF

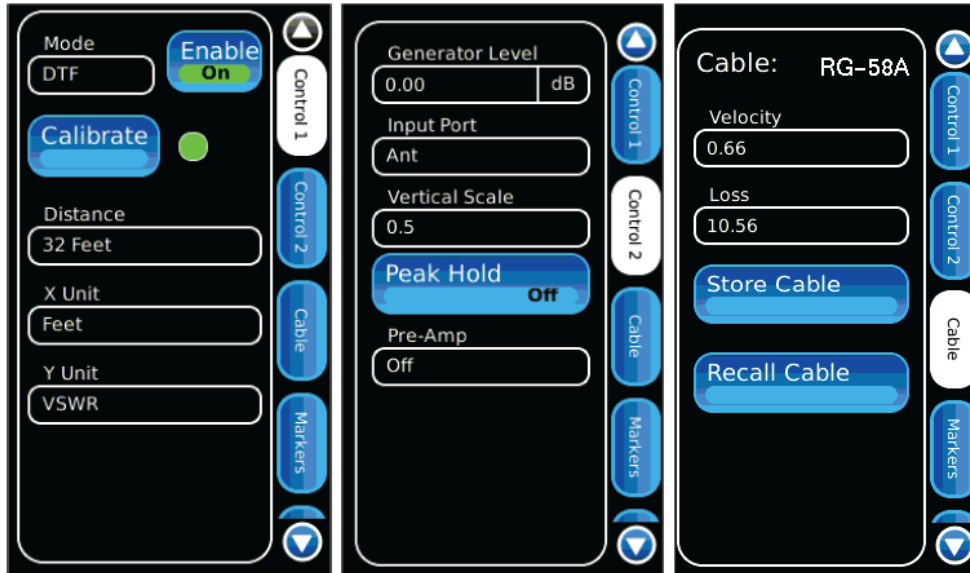

1. Connect the precision 50 Ohm termination to the Power Divider DUT Port.
2. Establish the settings as illustrated.
3. For Distance, enter a value that is longer than the expected length to be measured.
4. On the Cable Tab, choose the cable type from the recall cable menu or directly enter the velocity factor and loss per 100 ft. (if known).

Measuring DTF

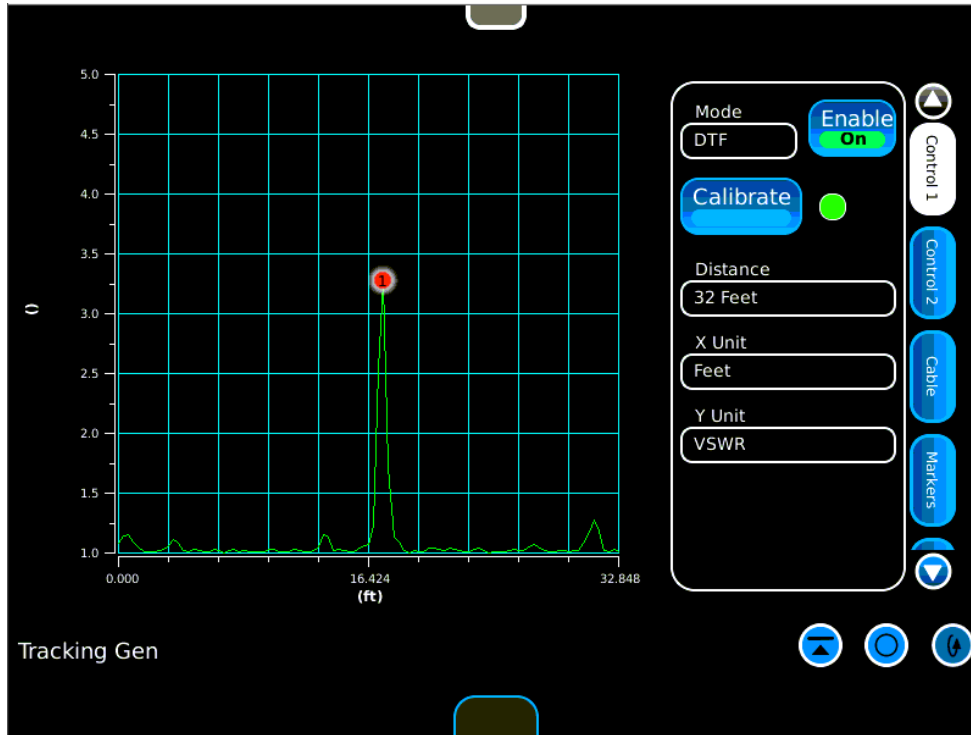

1. Press the Calibrate Button on the Control 1 Tab.
2. Remove the 50 Ohm termination and connect the transmission line and antenna to the DUT Port of the Power Divider.
3. Markers can be used to measure the distance to the antenna.

Digital Radio Testing

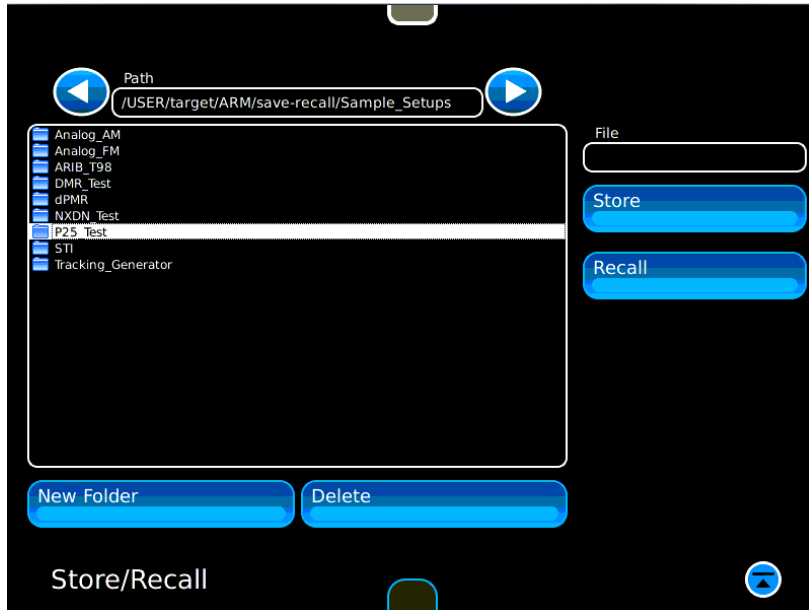

- From the Sample Setups area, highlight the P25 Test folder and press the  icon to enter the folder.

Digital Radio Testing

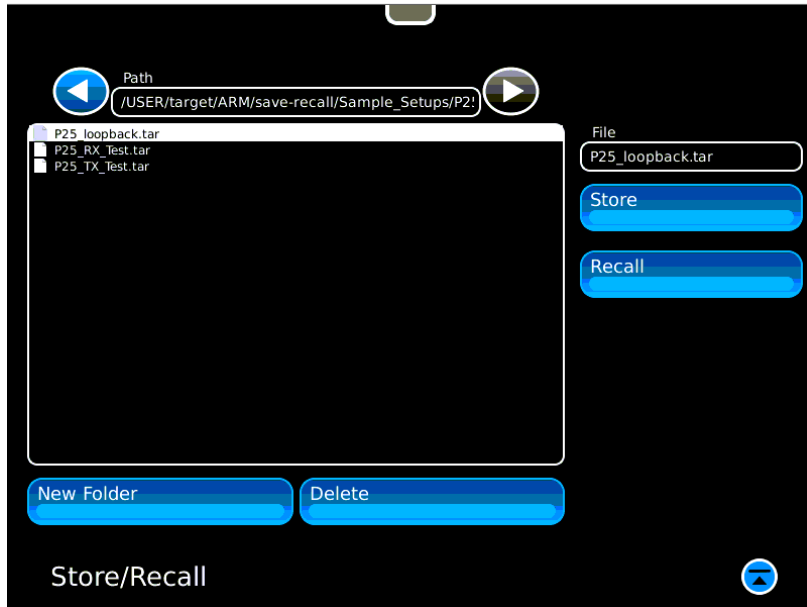

- From the P25 Tests folder, choose the P25 Loopback setup file.
- This file will recall the primary elements required to perform P25 Transmitter and Receiver tests.
- Upper and Lower limits will be configured for signals that have limits set by the technology standards.

Digital Radio Testing

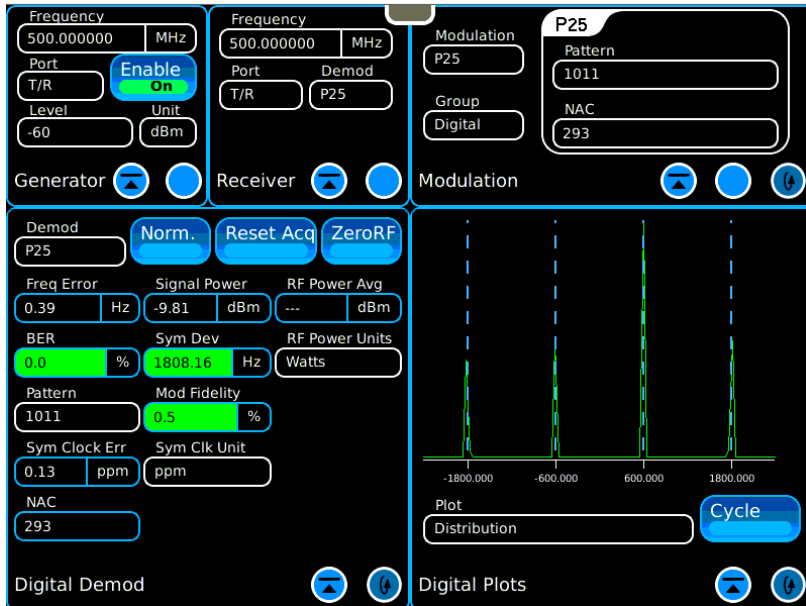

- After the setup has recalled, enable the RF Generator on the Generator Tile.
- The 8800SX is now generating a P25 signal into itself.
- The TX BER, Modulation Fidelity and Symbol Deviation Meters will show up as green on the Digital Demod Tile as they are within the preset limits set for these meters.

Digital Radio Testing

Transmitter Testing

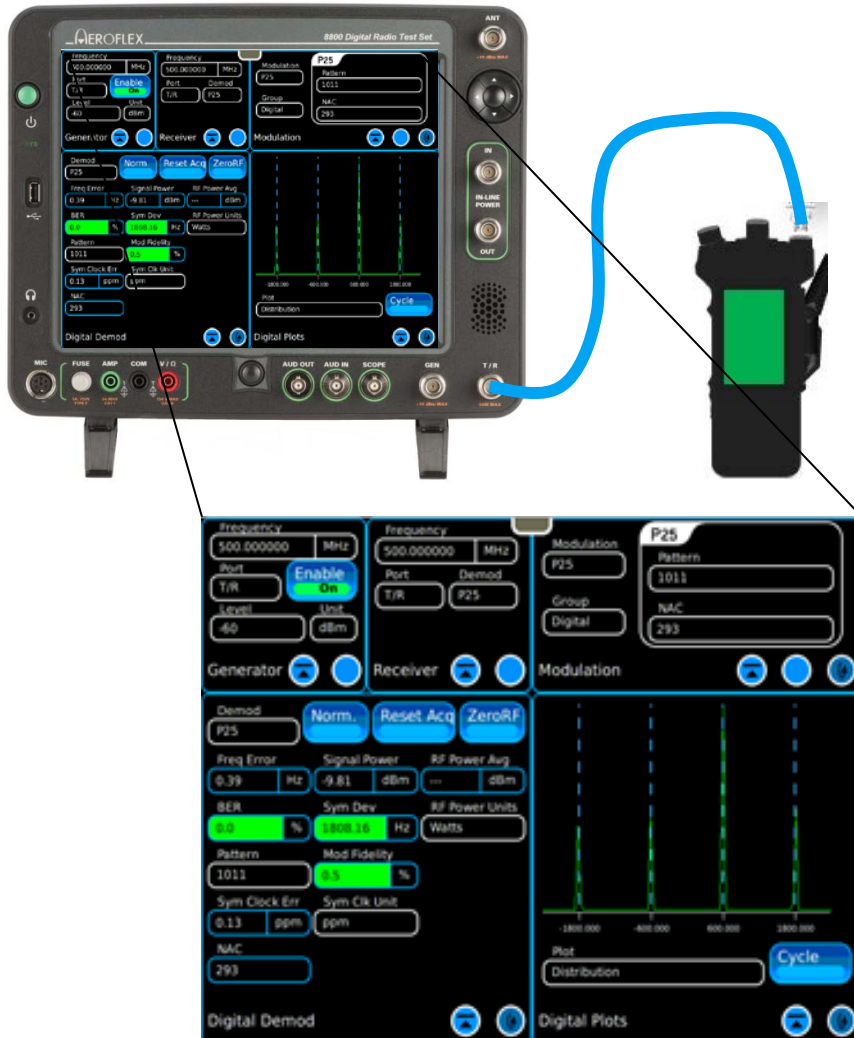

- Connect a conventional P25 radio to the 8800SX TR Port.
- Turn the 8800SX Generator Enable to OFF.
- Expand the Receiver tile and Key the transmitter. Use the “Freq Find” feature to find an unknown transmitter frequency or just enter the frequency on the receiver tile if the frequency is known.

Digital Radio Testing

Transmitter Testing

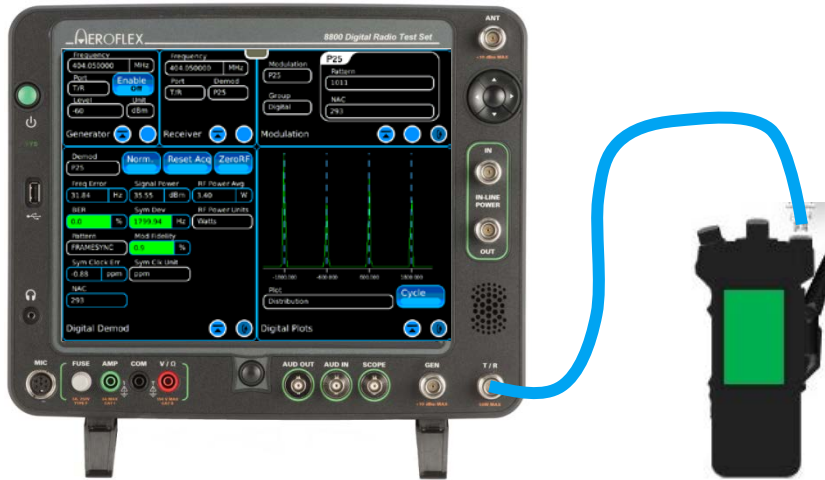

- On the 8800SX Digital Demod Tile, set the Pattern field to “FRAMESYNC” to measure TX BER on a voice channel.
- Use the Fast Stack feature to access the Modulation Tile in the upper right corner.

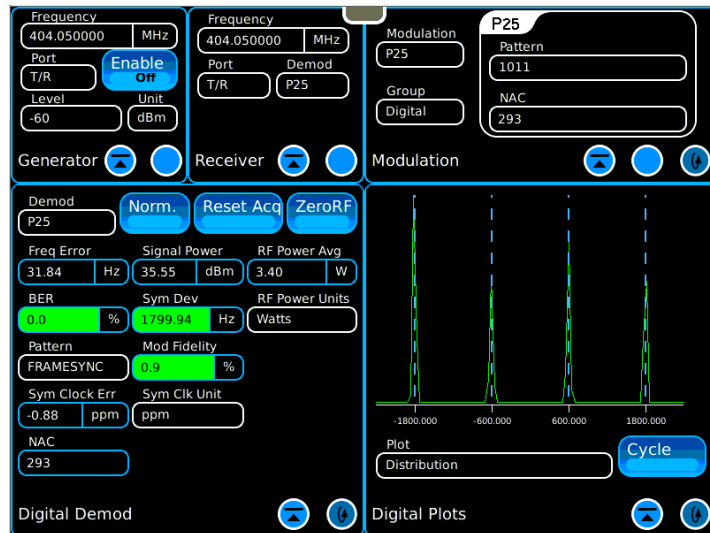

Digital Radio Testing

Transmitter Testing

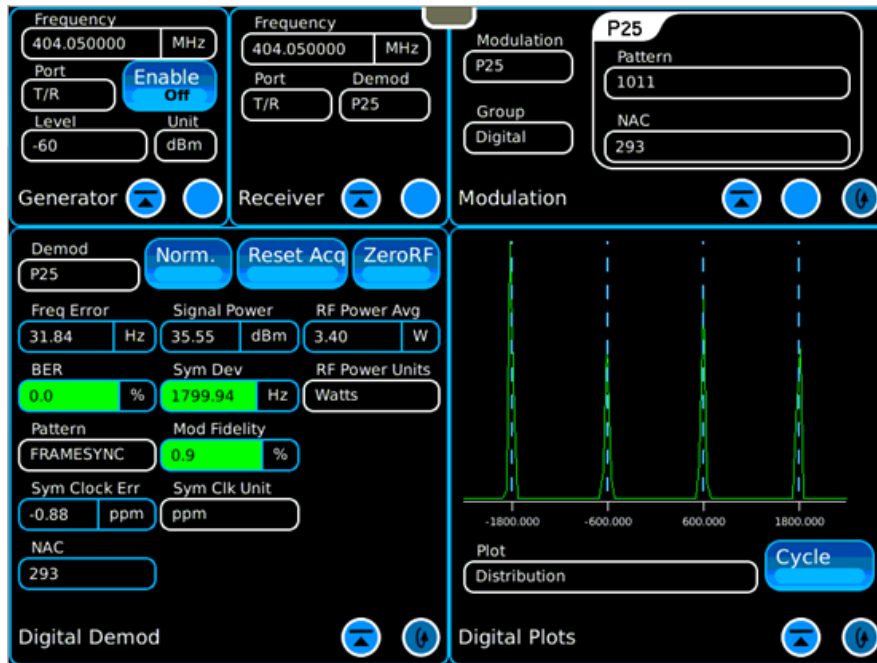

Demodulated audio is not available to the speaker on the 8800SX in Digital formats.

- Key the P25 conventional transmitter.
- Modulation Fidelity readings should be <5% Error.
- TX BER should be 0.
- Symbol deviation should be between 1620 Hz and 1980 Hz.
- Power and Frequency error should be within expected limits.
- Note the decoded NAC value on the Digital Demod panel as it will be programmed on the Modulation Tile to test the receiver.

Digital Radio Testing

Receiver Testing

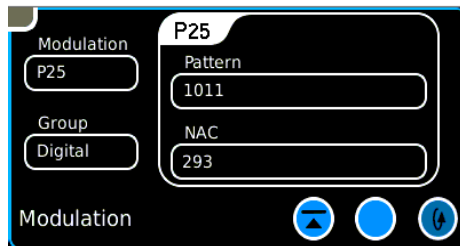

- Unkey the transmitter and enter the decoded NAC value on the Modulation Tile NAC field.
- On the 8800SX Generator Tile, enter the receiver frequency and set the Enable field to ON.
- A tone should be heard from the radio receiver now.
- The 8800SX generator level can be reduced to see what level produces an unstable tone in the receiver revealing the sensitivity of the receiver.

8800SX Options and Accessories

8800SX Options and Accessories

139942 8800SX Digital Radio Test Set

Standard Accessories

Fuse, 5 A, 32 V, Mini Blade	Power Supply
AC Power Cord - USA	AC Power Cord - China
AC Power Cord - Europe	AC Power Cord - UK
Adapter, N(m) to BNC(f), Qty 3	Front Cover
Internal Battery	

Options

113334	8800OPT01 DMR
113335	8800OPT02 dPMR
113336	8800OPT03 NXDN
113337	8800OPT04 P25
138895	8800OPT05 P25 Phase 2
140215	8800OPT06 DMR Repeater Test
113338	8800OPT09 ARIB T98
113339	8800OPT10 Tracking Generator
113340	8800OPT11 Occupied Bandwidth
113309	8800OPT12 Internal Precision Power Meter (Meter + Sensor)
113342	8800OPT13 External Precision Thru-Line Meter (for use with Bird WPS Sensor)
113343	8800OPT14 PTC
113344	8800OPT15 AAR Channel Plan
139836	8800OPT20 R&S NRT-Z Power Sensor Support
139837	8800OPT21 Selectable Notch Filters
139838	8800OPT22 SNR Meter
138525	8800OPT101 Kenwood NXDN Auto-Test
138526	8800OPT102 Kenwood 5X20 P25 Series Auto-Test
138527	8800OPT103 Motorola APX Auto-Test
138528	8800OPT104 Motorola MOTOTRBO™ Auto-Test
139315	8800OPT105 Motorola ASTRO® 25 XTS®/XTL™ Auto-Test

Languages

113350	8800OPT300 Simplified Chinese
113351	8800OPT301 Traditional Chinese

113352	8800OPT302 Spanish
113353	8800OPT303 Portuguese
113354	8800OPT304 Malay/Indonesian
113355	8800OPT305 Korean
113356	8800OPT306 Arabic
113357	8800OPT307 Polish
113358	8800OPT308 Russian
113359	8800OPT309 Japanese
113360	8800OPT310 German
113361	8800OPT311 French
139625	8800OPT312 Italian

Accessories

138313	Calibration Certificate - 8800 Series
82560	AC27003 Attenuator - 20 dB/150 W
67076	Spare Internal Battery
114479	External Battery Charger
114477	Hard Transit Case
114478	Soft Carrying Case
114475	Antenna Kit
114348	Precision DTF/VSWR Accessory Kit for 8800
63927	AC25081 Site Survey Software
92793	5017D Bird Power Sensor
114312	Mounting Bracket
112861	Microphone
62404	DC Cord/Cigarette Adapter
63936	AC24009 DMM Test Leads
112277	10 AMP Current Shunt, 0.01 Ohm
67411	Scope Probe Kit

Extended Warranties

114481	Extended Standard Warranty 36 Months
114482	Extended Standard Warranty 60 Months
114483	Extended Standard Warranty 36 Months with Scheduled Calibration
114484	Extended Standard Warranty 60 Months with Scheduled Calibration

Select 8800SX Accessories Overview

Soft Case 114478

The soft case allows full operation of the 8800SX while inside the case. The laptop style design is lightweight and provides extra protection during field operation. Storage pockets provide extra space for spare batteries, test cables, etc.



Hard Transit Case 114477

The hard transit case features form-fitted slots for the 8800SX, protective cover, precision VSWR/DTF Kit, power supply, 150 W attenuators, spare battery, and more.



Precision DTF/VSWR Accessory Kit 114348

This accessory kit provides all items necessary for accurate and VSWR, Return Loss, and Distance-to-Fault measurement. The kit includes a case, return loss bridge, power divider, 50 Ω calibrator, and two N-type test cables specifically designed for the 8800SX.



Bird 5017D Thru-Line Power Sensor 92793

The 8800SX also supports the Bird 5017D Thru-Line Power Sensor as an external power meter for users that already have the 5017D. This capability requires 88XOPT13 and provides simultaneous forward and reverse power measurements up to 500 W and VSWR measurements that are displayed on the 8800SX screen.



Questions or Comments?

Contact Information

For information about pricing for our products, contact the sales office by calling VIAVI Solutions at (800) 835-2352 or emailing AvComm.Sales@viavisolutions.com.

For technical/product support, calibration, maintenance and general customer service inquiries, you can contact our help desk by [clicking here](#), calling (800) 835-2350, or emailing Service.Americas@aeroflex.com.

[Click here](#) for more information on the 8800SX and latest software versions and training materials.