

RF Test Antennas



Table of Contents

Selection Table	3
Omni Antenna	
G700050353, G700050354, G700050355, G700050356, G700050357, G700050350	4
Dual Band Omni Antenna	
G700050359	8
Mag Mount Omni Antenna	
G700050358	10
G700050340	11
G700050342	12
G700050344	14
G700050345	16
Yagi Antenna	
G700050363	18
G700050365	19
Broadband Log Periodic Antenna	
G700050366, G700050367	20
Horn Antenna	
G700050370	21
Isotropic Antenna	
G700050380	22
G700050381	23
GPS Antenna	
JD71050351	24
G700050390	25
JD72050005	26

Selection Table

Antenna Type	Catalog Number	Connector	Frequency Range
Omni Antenna	G700050353	N plug (male)	806 to 896 MHz
	G700050354	N plug (male)	870 to 960 MHz
	G700050355	N plug (male)	1710 to 2170 MHz
	G700050356	N plug (male)	720 to 800 MHz
	G700050357	N plug (male)	2300 to 2700 MHz
	G700050350	N plug (male)	3300 to 3800 MHz
Dual Band Omni Antenna	G700050359	N plug (male)	2400 to 2500 MHz
			5100 to 5900 MHz
Mag Mount Omni Antenna	G700050358	N plug (male)	689 to 6000 MHz
	G700050340	K jack (female)	26500 to 40000 MHz
	G700050342	K jack (female)	26500 to 40000 MHz
	G700050344	SMA jack (female)	600 to 6000 MHz
	G700050345	N plug (male)	600 to 6000 MHz
Yagi Antenna	G700050363	N jack (female)	1750 to 2390 MHz
	G700050365*	N jack (female)	866 to 960 MHz
Log Periodic Antenna	G700050366	SMA jack (female)	650 to 4000 MHz
	G700050367	SMA jack (female)	650 to 6000 MHz
Horn Antenna	G700050370	K jack (female)	26500 to 40000 MHz
Isotropic Antenna	G700050380	N plug (male)	26 to 3000 MHz
	G700050381	N plug (male)	400 to 6000 MHz (usable down to 30 MHz)
GPS Antenna	JD71050351	SMA plug (male)	L1 1575.42 MHz
	G700050390	SMA plug (male)	L1 1575.42 MHz
	JD72050005**	USB Type A	L1 1575.42 MHz

* Not available for EU countries

** For JD720C series only

Omni Antenna

Specifications

VIAVI Omni antennas are used for both indoor and outdoor applications. They are constructed with a Type N male connector to make it easy for a direct attachment.

Catalog Number	G700050353	G700050354	G700050355	G700050356	G700050357
Mechanical Data					
Length (L1)					
	2270 ± 3.0 mm	223.0 ± 3.0 mm	143.0 ± 3.0 mm	266.0 ± 3.0 mm	129.0 ± 3.0 mm
Connector	Type N plug (male)				
Environmental Data					
Operating Temperature	-20 to +70°C	-20 to +70°C	-20 to +70°C	-20 to +70°C	-20 to +70°C
Electrical Data					
Frequency Range	806 to 896 MHz	870 to 960 MHz	1710 to 2170 MHz	720 to 800 MHz	2300 to 2700 MHz
Gain	> 1 dBi	> 1 dBi	> 1 dBi	> 1 dBi	> 1 dBi
VSWR	≤ 2.4:1 (806 to 816 MHz)	≤ 2.0:1	≤ 2.0:1	≤ 2.0:1 (720 to 780 MHz)	≤ 2.0:1
	≤ 2.0:1 (816 to 896 MHz)			≤ 2.4:1 (780 to 800 MHz)	
Impedance	50 Ω	50 Ω	50 Ω	50 Ω	50 Ω
Maximum Power	50 W	50 W	50 W	50 W	50 W

Antenna Pattern

G700050353 (806 to 896 MHz)

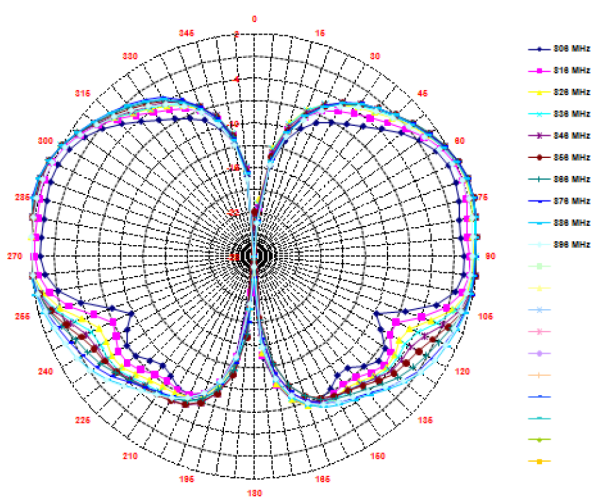

G700050354 (870 to 960 MHz)

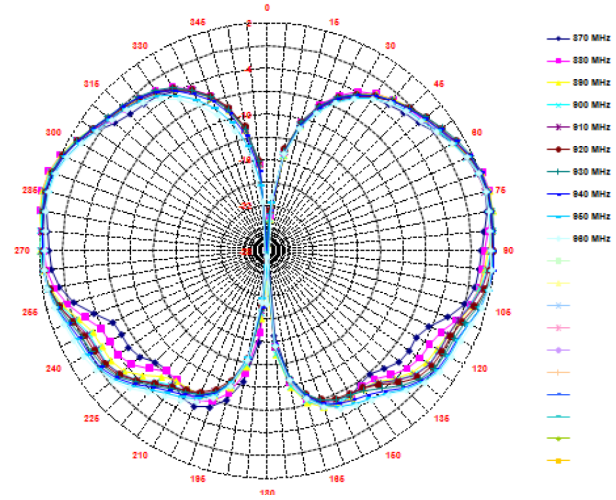

G700050355 (1710 to 2170 MHz)

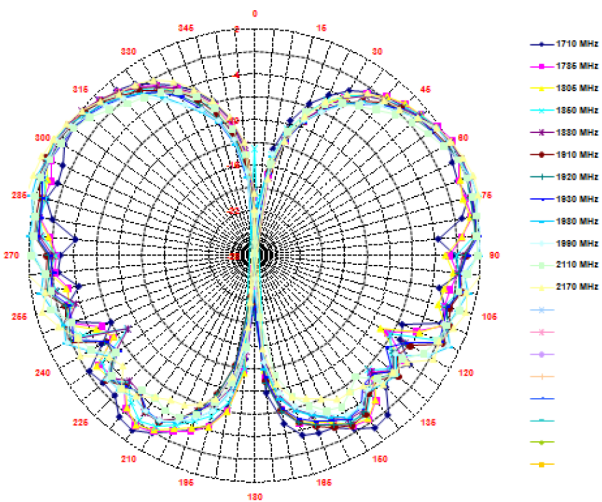

G700050356 (720 to 800 MHz)

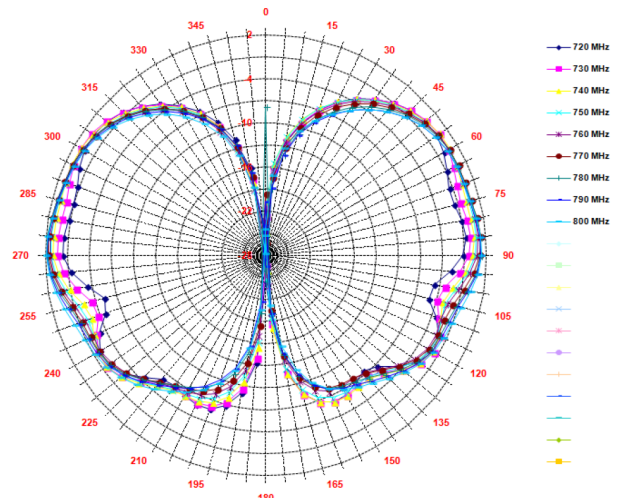

G700050357 (2300 to 2700 MHz)

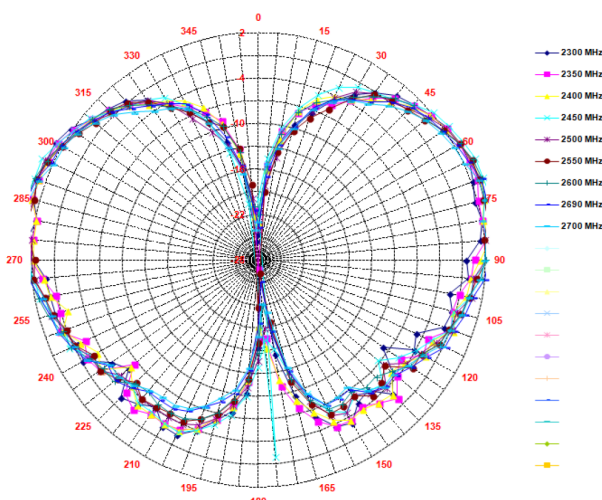

Specifications

Catalog Number	G700050350
-----------------------	-------------------

RF omni antenna, N(m), 3.3 to 3.8 GHz, 4 dBi

Mechanical Data

Dimension	280 x 24 mm (11.02 x 0.94 in)
Connector	Type N plug (male)



Electrical Data

Frequency Range	3300 to 3800 MHz
Gain	> 4 dBi
VSWR	≤ 2.0:1
Impedance	50 Ω

Antenna Pattern

3300 MHz

E-plane

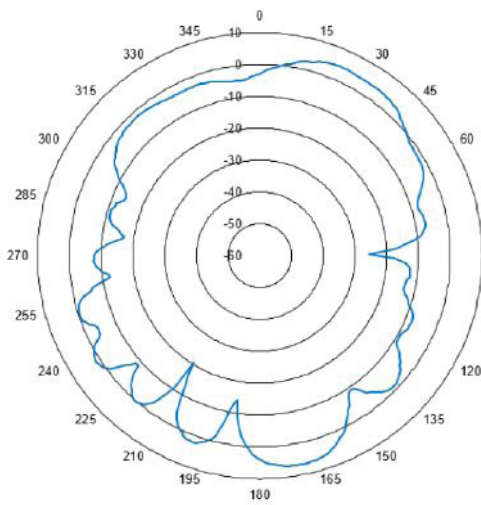

H-plane

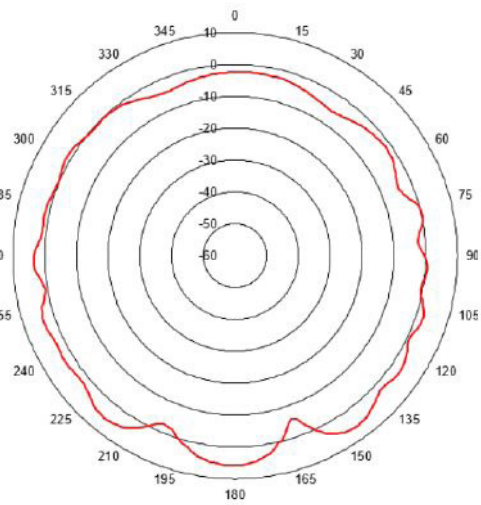

3550 MHz

E-plane

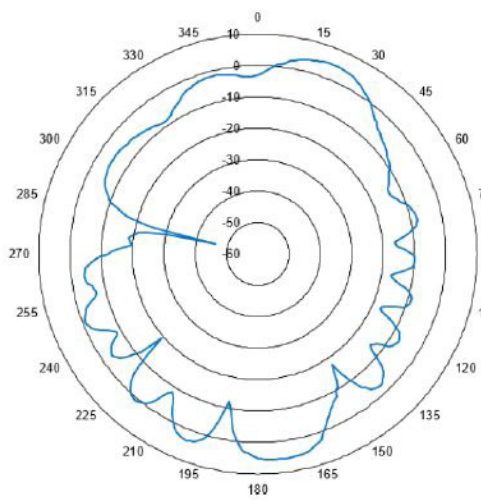

H-plane

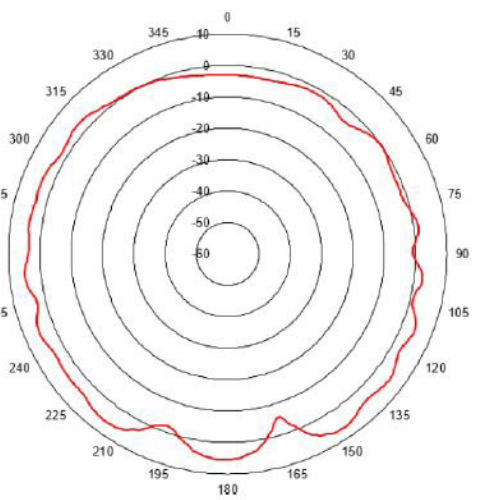

3800 MHz

E-plane

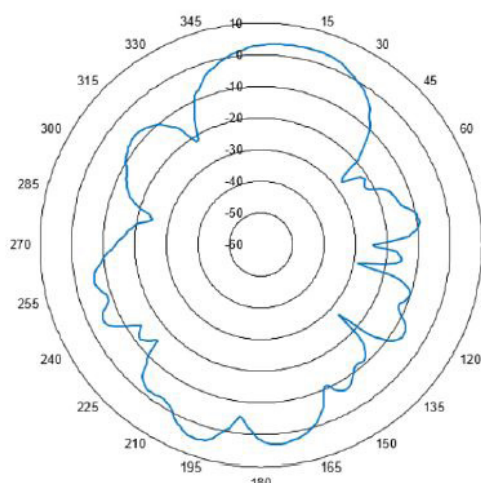

H-plane

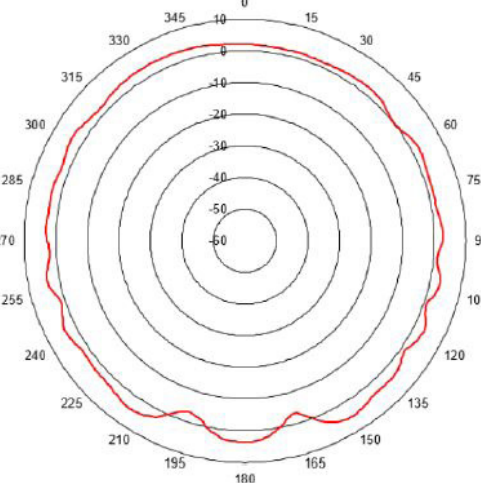

Dual Band Omni Antenna

Specifications

Catalog Number	G700050359
-----------------------	-------------------

RF omni antenna, N(m), 2.4 to 2.5 GHz, 4.5 dBi, and 5.15 to 5.85 GHz, 7 dBi

Mechanical Data

Dimension	180 x 23 mm (7.07 x 0.89 in)
------------------	------------------------------



Radome Material	ABS
Connector	Type N plug (male)

Electrical Data

Frequency Range	2400 to 2500 MHz
	5150 to 5850 MHz
Gain	4.5 dBi (2400 to 2500 MHz)
	7 dBi (5150 to 5850 MHz)
VSWR	≤ 2.0:1
Impedance	50 Ω
Electrical Wave	1/4

Antenna Pattern

2.4 GHz

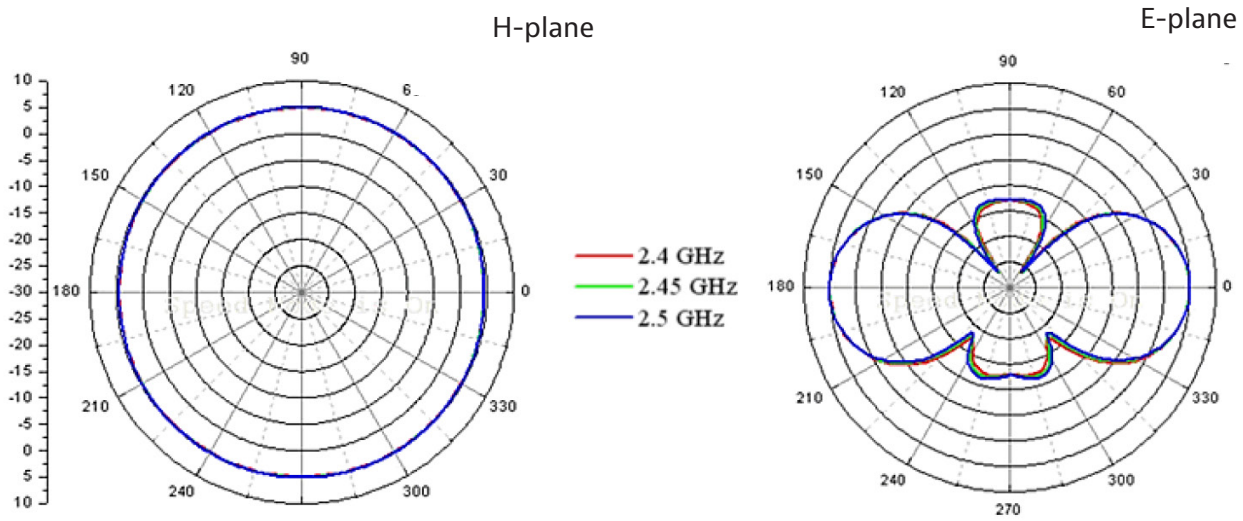

5.8 GHz

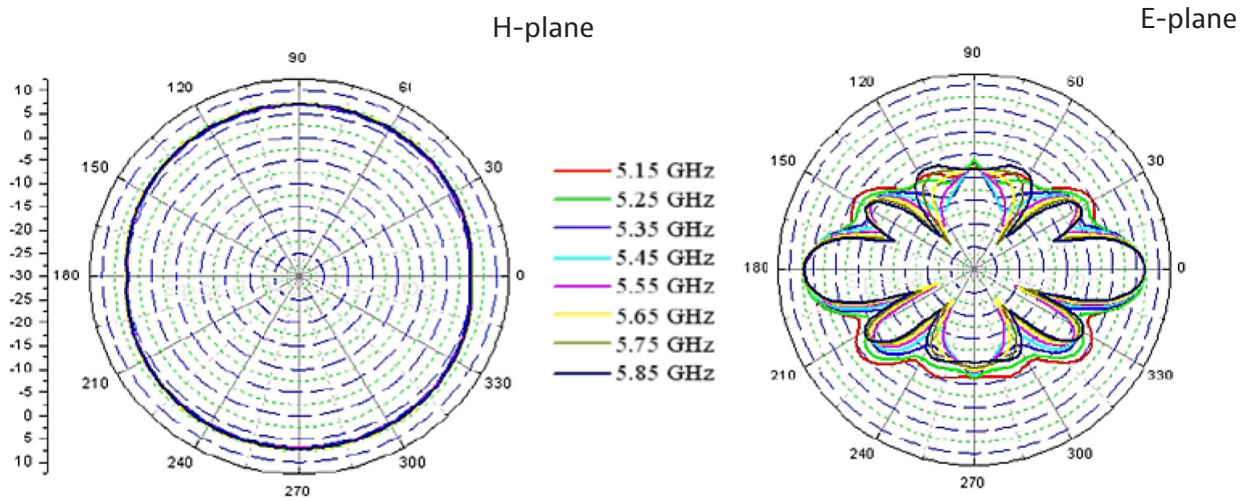

Mag Mount Omni Antenna

Specifications

Catalog Number	G700050358
-----------------------	-------------------

Mag mount RF omni antenna, N(m), 694 to 6000 MHz

Mechanical Data	
Dimension	107 x 107 x 93 mm (4.20 x 4.20 x 3.67 in)
Radome Material	Black ASA UV Inhibitive
Cable	RG-174, 8 ft. (GPS DC 3V and 5V)
	RF-195, 8 ft. (694-960/1710-3700 MHz)
	RF-195, 8 ft. (2.4 to 2.485 and 4.9 to 6.0 GHz)
Connector	RF: Type N plug (male)
	GPS: SMA plug (male)
Environmental Data	
Operating Temperature	-40 to +80°C
Shock and Vibration	IEEE1478, EN 61373, MIL-810G, TIA 329.2-C
Dust and Water Ingress	IP67
Electrical Data	
Frequency Range	RF: 694-960 MHz, 1710-3700 MHz, 2400 MHz, and 4900-6000 MHz
	GPS: 1575.42 ± 2 MHz
Gain	3 dBi (694 to 960 MHz)
	4 dBi (1710 to 3700 MHz)
	5 dBi (2.4 to 2.485 and 4.9 to 6.0 GHz)
GPS Unit Gain	26 dB, 5 dBi antenna
	3.3 and 5 V DC (Voltage)
	10 mA typical, 20 mA max. (Current)
VSWR	< 2.0:1
Impedance	50 Ω nominal
Maximum Power	10 W



Specifications

Catalog Number	G700050340
-----------------------	-------------------

Mag mount RF omni antenna, K(f), 26.5 to 40 GHz, 3 dBi

Mechanical Data	
Dimension	52 x 52 x 84.3 mm (2.05 x 2.05 x 3.32 in)
Weight	200 g (7.05 oz)
Radome Material	HDPE
Connector	K jack (female)
Environmental Data	
Operating Temperature	-40 to +85°C
Electrical Data	
Frequency Range	26500 to 40000 MHz
Gain	3 dBi typical*
Azimuth Gain Variation	± 1 dB
Azimuth Beam Width	360°
3 dB Vertical Beam Width	45°
Return Loss	8 dB
Maximum Power	200 W



* Catalog number G700050343 available for factory upgrade with LNA

Specifications

Catalog Number	G700050342
-----------------------	-------------------

Mag mount RF omni antenna with LNA, K(f), 26.5 to 40 GHz, 18 dBi

Mechanical Data

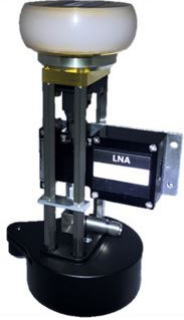
Dimension	54.20 x 80.0 x 125.5 mm (2.13 x 3.15 x 4.94 in)	
Weight	340 g (11.99 oz)	
Radome Material	HDPE	
Connector 1	K jack (female)	
Connector 2	USB Type C with locking screw	
Environmental Data		
Operating Temperature	-20 to +65°C	
Electrical Data		
Frequency Range	26500 to 40000 MHz	
Gain	18 dBi typical (3 dBi from the antenna and 15 dBi from the integrated LNA)	
Azimuth Gain Variation	± 1 dB	
Azimuth Beam Width	360°	
3 dB Vertical Beam Width	45°	
P1dB	11 dBm	
Return Loss	10 dB	
RF Input Power	-8 dBm maximum	
Damage RF Input Power	-3 dBm maximum	
Supply Voltage	4.8 V DC minimum, 5 V DC typical, 20 V DC maximum	
Supply Current	150 mA typical	

Antenna Pattern

G700050340 (28 GHz)

E-plane

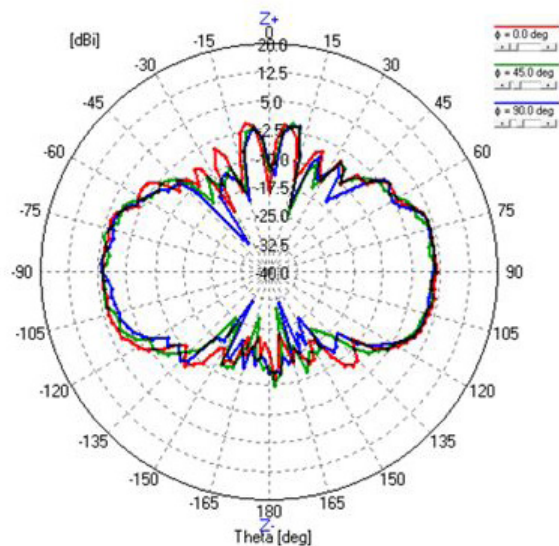

H-plane

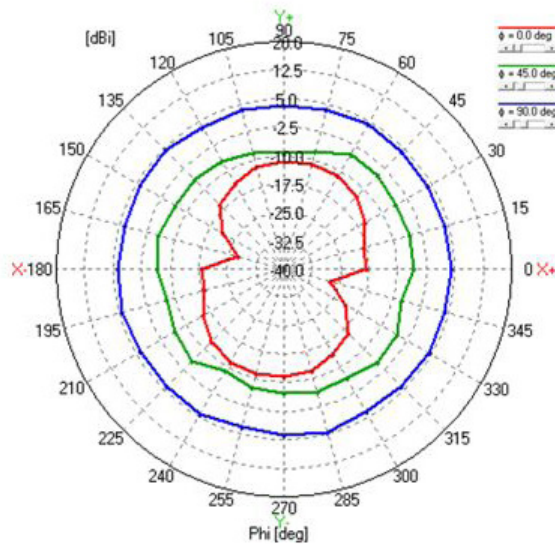

G700050342 (28 GHz)

E-plane

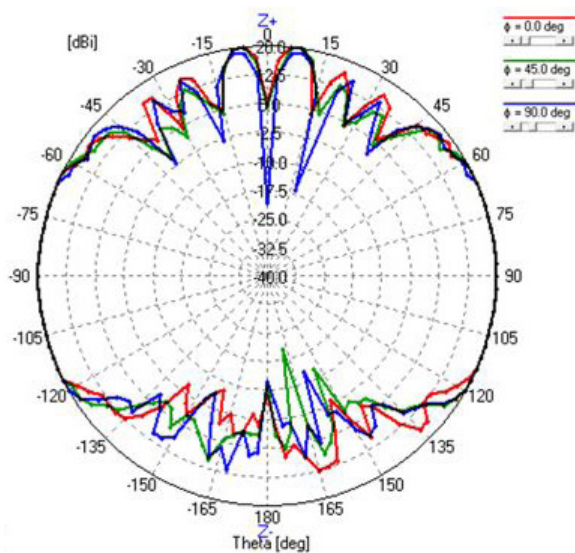

H-plane

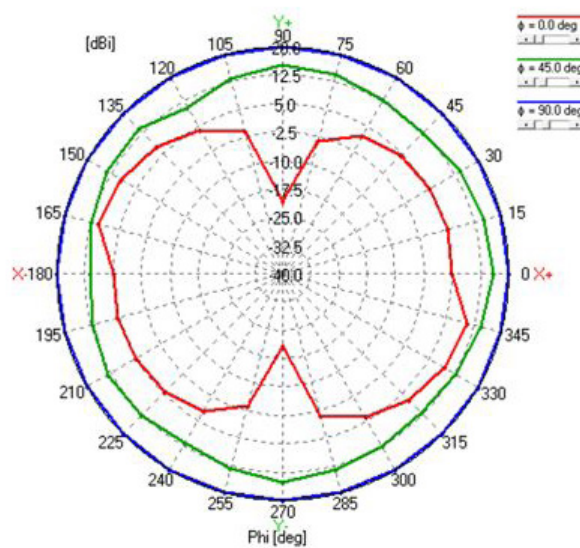

Specifications

Catalog Number **G700050344**

Mag mount RF omni antenna, SMA(f), 600 MHz to 6 GHz

Mechanical Data						
Dimension	213.5 x 75.5 mm (8.41 x 2.97 in)					
Weight	220 g (7.8 oz)					
Antenna Casing Material	UV Resistant PC/ABS					
Connector	SMA jack (female)					
Environmental Data						
Operating Temperature	-40 to +85°C					
Electrical Data						
Frequency Range	600 to 6000 MHz					
Peak Gain (dBi)	Bent Free Space					
	617-698 5G NR Band 71	698-824 LTE 700	824-960 GSM 850/900	1427-1518 5G Band 74/75/76	1710-1880 DCS	1850-1990 PCS
	1.68	2.73	2.16	2.14	3.62	3.5
	1920-2170 UMTS1	2300-2690 LTE 2600	3300-3500 5G Band 77/78/79	3400-3800 5G Mid	3600-4600 Japan 5G	5150-5925 LTE 5200/ Wi-Fi 5800
	3.7	2.8	-0.31	0.14	1.02	3.02
	Straight Free Space					
	617-698 5G NR Band 71	698-824 LTE 700	824-960 GSM 850/900	1427-1518 5G Band 74/75/76	1710-1880 DCS	1850-1990 PCS
	1.82	1.5	1.63	1.88	3.21	2.91
	1920-2170 UMTS1	2300-2690 LTE 2600	3300-3500 5G Band 77/78/79	3400-3800 5G Mid	3600-4600 Japan 5G	5150-5925 LTE 5200/ Wi-Fi 5800
	2.69	1.55	-0.61	-0.28	0.53	2.25
Impedance	50 Ω nominal					
Maximum Power	5 W					

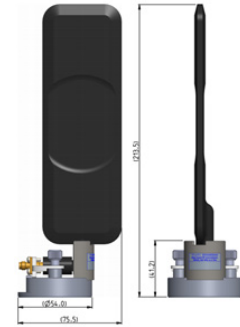

Antenna Pattern

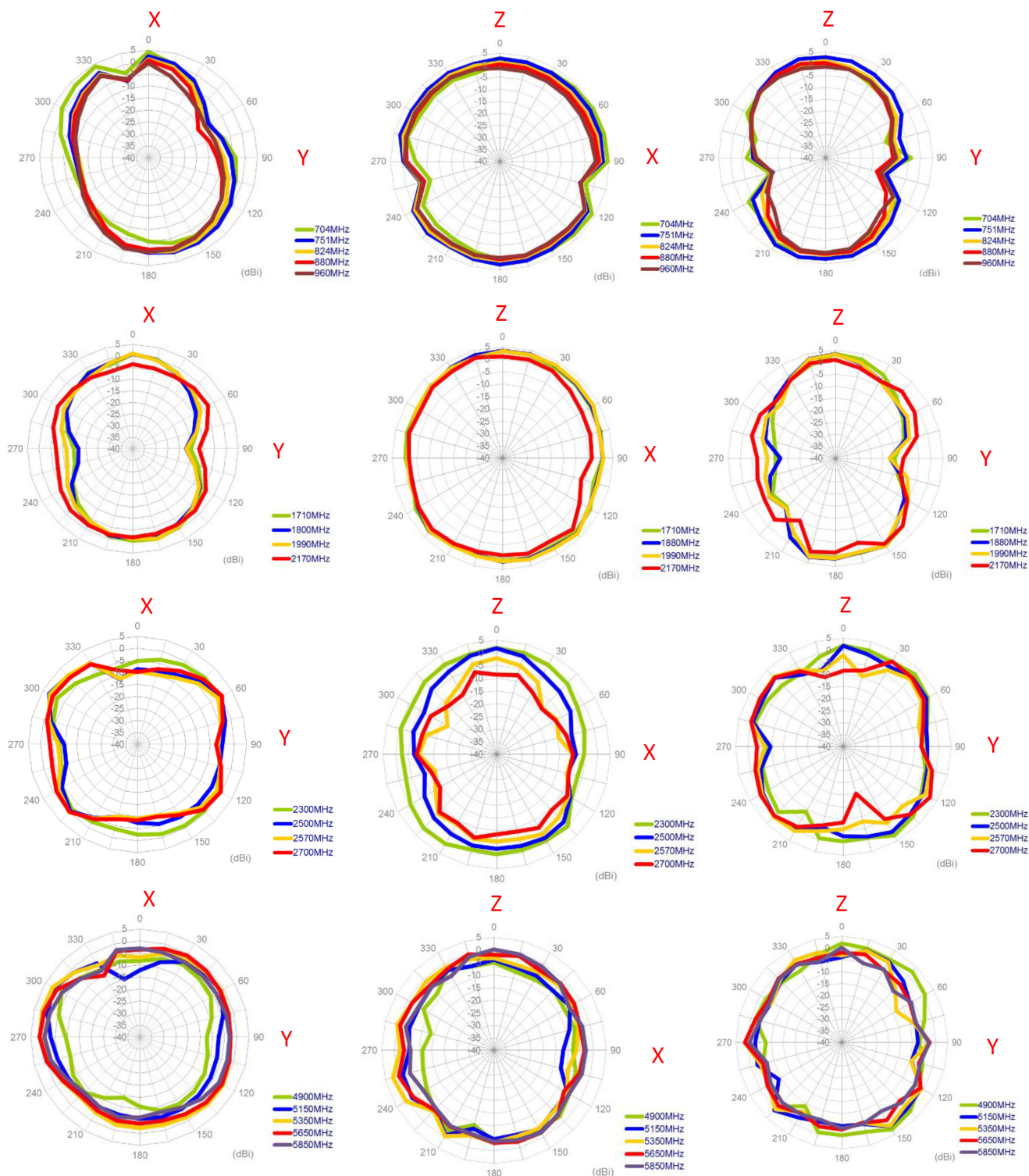
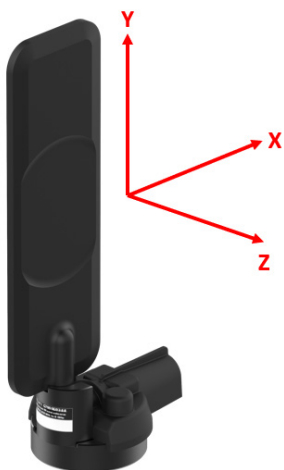

Specifications

Catalog Number	G700050345
-----------------------	-------------------

Mag Mount RF Omni Antenna 617-960/1700-6000 MHz 8 ft. LL-195 with N-plug

Mechanical Data

Dimension	1.7" diameter x 3 5/8" high (43 mm x 92 mm) Mag base dia. 2 5/8" (67mm)
Radome	Black ABS Plastic
Cable	8 ft. LL-195
Connectors	N plug



Environmental Data

Operating Temperature	-40 to +80°C
Shock & Vibration	IEEE1475, EN 61373, MIL-STD-810G
Dust & Water Ingress	IPX5

Electrical Data

Frequency Range	617-960/1700-6000 MHz
Peak Gain	3 dBi
VSWR	2.0:1
Impedance	50 Ω nominal
Maximum Power	10 Watts

Antenna Pattern

620 MHz – Elevation Plot

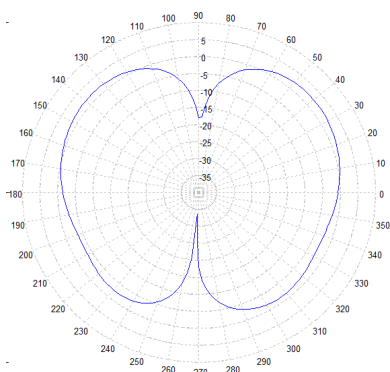

960 MHz – Elevation Plot

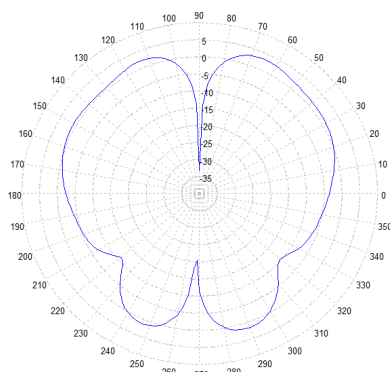

1950 MHz – Elevation Plot

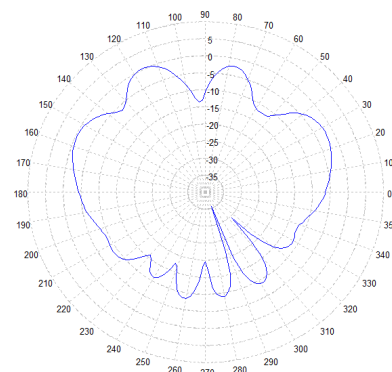

620 MHz – Azimuth Plot

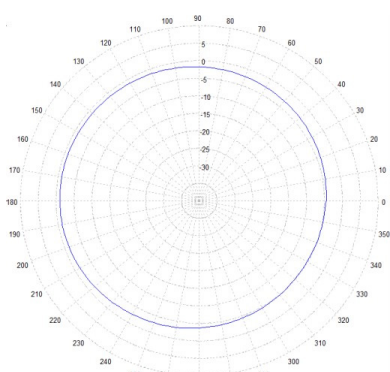

960 MHz – Azimuth Plot

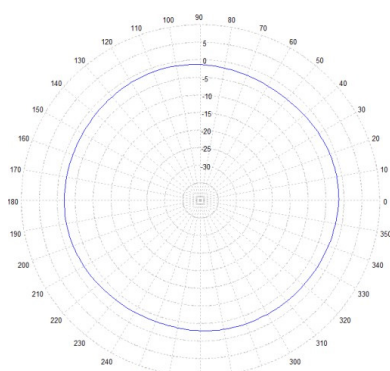

1950 MHz – Azimuth Plot

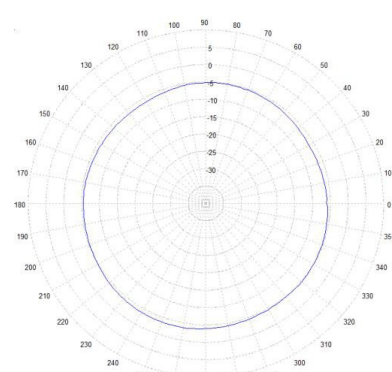

2600 MHz – Elevation Plot

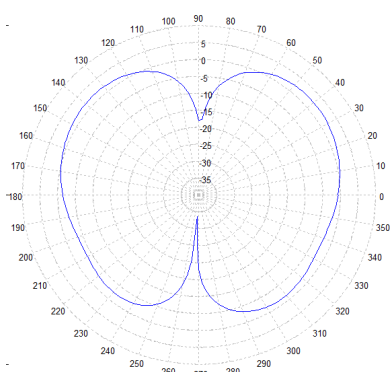

3800 MHz – Elevation Plot

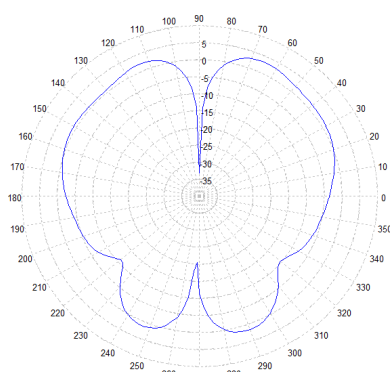

5500 MHz – Elevation Plot

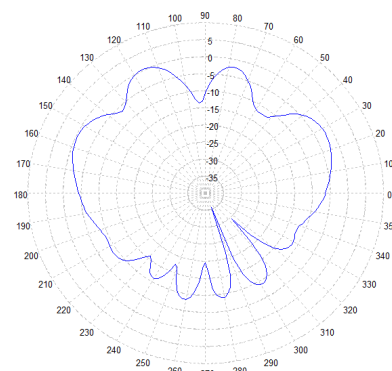

2600 MHz – Azimuth Plot

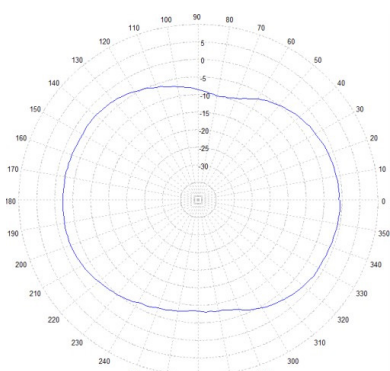

3800 MHz – Azimuth Plot

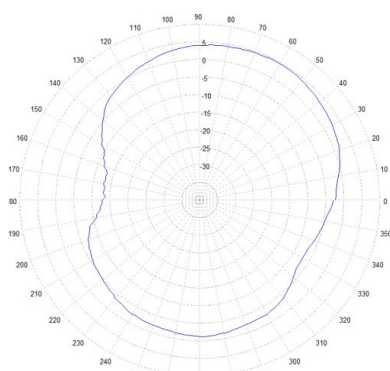

5500 MHz – Azimuth Plot

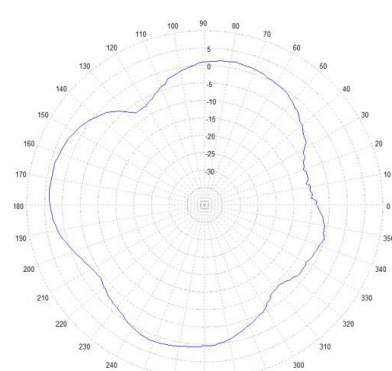

Yagi Antenna

Specifications

VIAVI directional Yagi antennas are designed to receive the signal from the Base Station with ruggedized aluminum and/or stainless-steel construction. They are ideal for outdoor applications such as Over The Air (OTA) measurement and interference analysis.

Catalog Number	G700050363
-----------------------	-------------------

RF Yagi antenna, N(f), 1750 to 2390 MHz

Mechanical Data	
Dimension	200 x 200 x 603 mm (7.87 x 7.87 x 23.74 in)
Weight	≤ 2 kg (incl. bracket)
Radome Material	ASA
Connector	Type N jack (female)
Withstand Wind Pressure	60 m/sec
Mechanical Tilt	± 30° (Up, Down) ± 30° (Left, Right)
	
Environmental Data	
Operating Temperature	-40 to +70°C
Electrical Data	
Frequency Range	1750 to 2390 MHz
Polarization	Vertical
Band Width	640 MHz
Gain	≥ 13 dBi
Beam Width	45 ± 5° (Horizontal) 40 ± 5° (Vertical)
VSWR	< 1.4:1
Impedance	50 Ω
Maximum Power	50 W

Catalog Number	G700050365
-----------------------	-------------------

RF Yagi antenna, 866 to 960 MHz

Mechanical Data

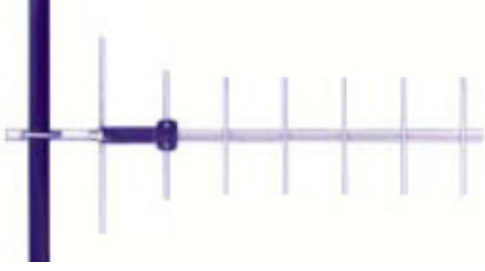
Dimension	Length 660 mm (25.98 in)	
Weight	< 907 g (2 lbs.)	
Material	1/2" aluminum U channel boom	
	1/4" solid elements	
	UV inhibited polyester coat	
Connector	Type N jack (female)	
Withstand Wind Pressure	125 MPH	
Electrical Data		
Frequency Range	866 to 960 MHz	
Gain	10.2 dBi	
Beam Width	55° (Horizontal)	
	50° (Vertical)	
VSWR	< 2.0:1	
Impedance	50 Ω	
Maximum Power	300 W	

Antenna Pattern

G700050363 (1750 to 2390 MHz)

Horizontal Pattern

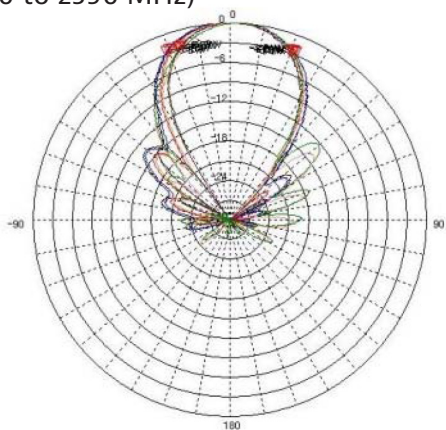

Vertical Pattern

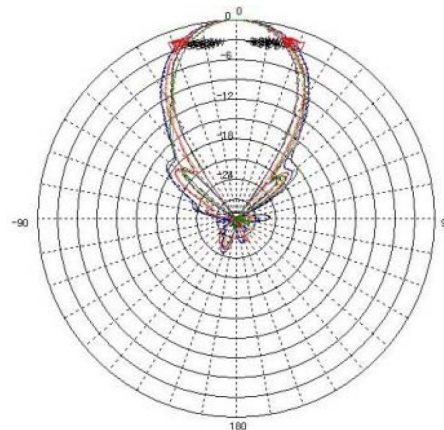

G700050365 (866 to 960 MHz)

Horizontal Pattern

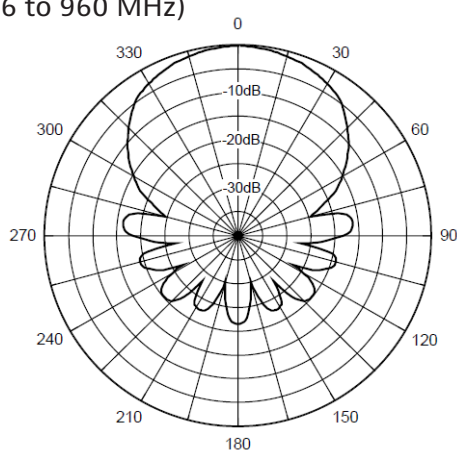

Vertical Pattern

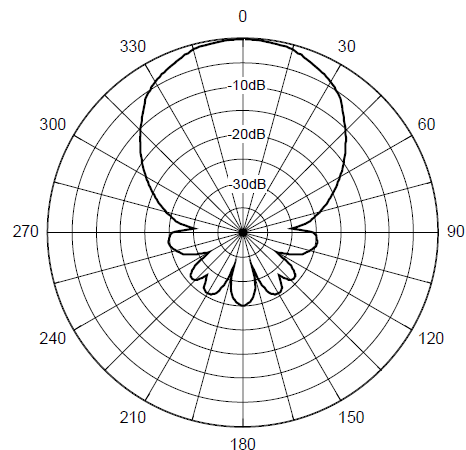

Broadband Log Periodic Antenna

Specifications

VIAVI broadband log periodic antenna is an extremely cost-effective solution that works with an AntennaAdvisor handle and CellAdvisor base station analyzer to let technicians at any skill level quickly identify and isolate RF interference. With a wide frequency coverage (up to 6 GHz), field technicians working in the cellular spectrum only need this one antenna for different cellular bands. A robust design and rugged construction with a high-tech radome housing protects against mechanical stress and environmental influence without sacrificing performance. This antenna can be used with optional JD70050007 AntennaAdvisor Handle.

Catalog Number	G700050366	G700050367
Mechanical Data		
Dimension	197 x 310 x 25.4 mm (7.75 x 12.20 x 1 in)	
Connector	SMA jack (female)	SMA jack (female)
Environmental Data		
Operating Temperature	-30 to +70°C (-22 to 158°F)	-30 to +70°C (-22 to 158°F)
Electrical Data		
Frequency Range	650 to 4000 MHz	650 to 6000 MHz
Gain	5 dBi	5 dBi
VSWR	< 2.0:1	< 2.0:1
Maximum Power	50 W	50 W

Antenna Pattern

G700050367 (650 to 6000 MHz)

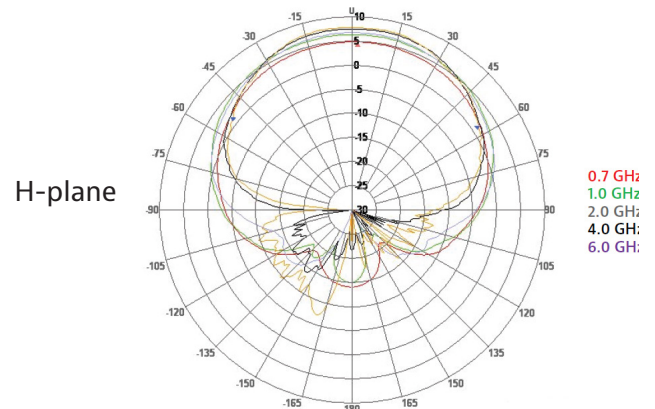
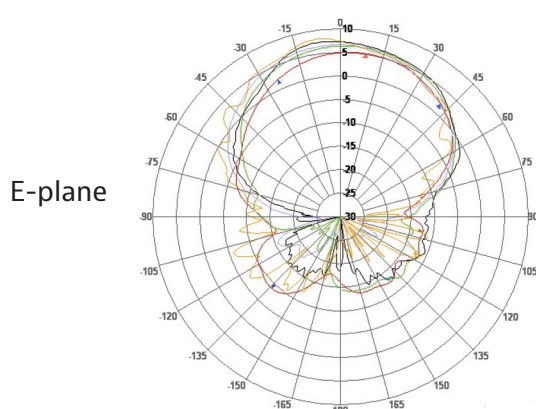

Horn Antenna

Specifications

Catalog Number	G700050370
-----------------------	-------------------

RF directional horn antenna kit that includes a 26.5 to 40 GHz horn antenna, a tripod handle, a 40 GHz cable, and a hard carrying case.

Mechanical Data

Dimension	93.73 x 36.83 x 27.94 mm (3.69 x 1.45 x 1.10 in)	
Connector	K jack (female)	

Electrical Data

Frequency Range	26.5 to 40 GHz	
Polarization	Linear	
Gain	20 dBi	
3 dB Beam Width	16.7° (E-Plane)	
	18.3° (H-Plane)	
VSWR	≤ 1.25:1	
Impedance	50 Ω nominal	

Isotropic Antenna

Specifications

Catalog Number	G700050380
-----------------------	-------------------

Isotropic antenna, N(m), 26 MHz to 3 GHz

Mechanical Data

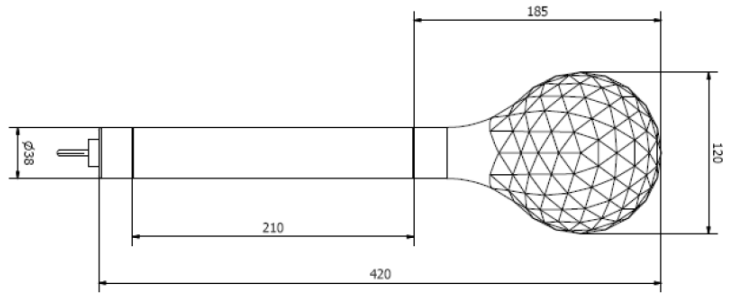
Dimension	120 x 120 x 420 mm (4.7 x 4.7 x 16.5 in)	
Connector	Type N plug (male)	
Environmental Data		
Operating Temperature	-10 to +50°C	
Electrical Data		
Frequency Range	26 to 3000 MHz	
Dynamic Range	1 mV – 300 V/m (26 to 500 MHz)	
	0.2 mV/m – 200 V/m (500 to 3000 MHz)	
	Up to 1000 V/m for frequencies < 110 MHz	
Maximum Field Strength (destruction limit)	400 V/m (500 to 3000 MHz)	
Isotropy	< ± 0.6 dB (26 to 2000 MHz) • 900 MHz: < ± 0.50 dB • 1800 MHz: < ± 0.55 dB	
	< ± 1 dB (2000 to 3000 MHz)	
Impedance	50 Ω	
Control and Power Supply	USB	

Catalog Number	G700050381
-----------------------	-------------------

Isotropic antenna, N(m), 400 MHz to 6 GHz

Mechanical Data	
Dimension	130 x 130 x 390 mm (5.12 x 5.12 x 15.35 in)
Weight	0.6 kg (21.16 oz)
Connector	Type N plug (male)
Environmental Data	
Operating Temperature	-20 to +55 °C
Electrical Data	
Frequency Range	400 to 6000 MHz (usable down to 30 MHz)
Linear Dynamic Range	0.2 mV/m to 200 V/m (1 dB compression point)
Sensitivity	< 0.3 mV/m
Maximum Field Strength (destruction limit)	300 V/m
Isotropy	± 1.5 dB (400 to 1500 MHz)
	± 2.0 dB (1500 to 2000 MHz)
	± 2.5 dB (2000 to 3500 MHz)
	± 3.5 dB (3500 to 6000 MHz)
Impedance	50 Ω
Control and Power Supply	USB



Typical Antenna Factors

Frequency (MHz)	Antenna Factor (dB/m typical)	Frequency (MHz)	Antenna Factor (dB/m typical)	Frequency (MHz)	Antenna Factor (dB/m typical)
400	51.9	2400	43.2	4400	46.5
600	50.2	2600	42.2	4600	47.7
800	46.5	2800	42.2	4800	46.8
1000	45.1	3000	43.5	5000	49.0
1200	43.1	3200	43.3	5200	47.6
1400	44.0	3400	45.0	5400	48.8
1600	41.8	3600	44.1	5600	49.0
1800	43.3	3800	45.9	5800	48.5
2000	43.9	4000	45.1	6000	49.6
2200	42.9	4200	46.7		

Included Accessories

- SDSW-03, USB remote axis selector
- 1.5m composite cable, ferritized, with calibration certificated of attenuation and return loss (typ. atten. 2.0 dB @3 GHz, 3.0 dB @6 GHz)
- Vertical support for fixing to ¼" thread
- Calibration certificate with antenna factor and return loss of three antennas
- Hard carrying case

GPS Antenna

Specifications

Catalog Number	JD71050351
-----------------------	-------------------

GPS antenna with cable

Mechanical Data

Dimension	45 x 45 x 13 mm (1.77 x 1.77 x 0.51 in)
------------------	---



Weight	110 g (incl. 5 m cable and connector)
---------------	---------------------------------------

Cable Length	5 m (16.4 ft)
---------------------	---------------

Connector	SMA plug (male)
------------------	-----------------

Environmental Data

Operating Temperature	-10 to +50°C
------------------------------	--------------

Electrical Data

Patch

Center Frequency	1575.42 MHz
-------------------------	-------------

Bandwidth (10 dB return loss)	10 MHz min @ S11-10 dB
--------------------------------------	--

Return Loss	-10 dB max.
--------------------	-------------

Gain at Zenith	5.0 dBi typical
-----------------------	-----------------

Polarization	RHCP
---------------------	------

Axial Ratio	3 dB typical
--------------------	--------------

Filter/LNA

Center Frequency	1575.42 MHz \pm 3
-------------------------	---------------------

Gain	28 dB typical (without cable)
-------------	-------------------------------

Noise Figure	1.2 dB typical
---------------------	----------------

Output VSWR	< 2.0:1
--------------------	---------

Voltage	2.7 to 5 V dc
----------------	---------------

Current	8 mA typical @ 3.3 V \pm 0.1 (11 mA max.)
----------------	---

Specifications

Catalog Number	G700050390
-----------------------	-------------------

GPS SMA mount antenna

Mechanical Data

Dimension	15.1 x 15.1 x 44.5 mm (0.59 x 0.59 x 1.75 in)	
Weight	30 g (1.06 oz)	
Radome Material	Black Ultem 1000	
Connector	SMA plug (male)	

Environmental Data

Operating Temperature	-40 to +71°C
------------------------------	--------------

Electrical Data

Center Frequency	1575.42 MHz
VSWR	≤ 3.0:1
Gain	-5 dBic ± 1 dB
Polarization	RHCP
Beam Width	120° x 120°
Axial Ratio at Zenith	4 dB typical
Impedance	50 Ω

Specifications

Catalog Number	JD72050005
-----------------------	------------

USB GPS receiver for JD720C series

Mechanical Data

Dimension	53 x 53 x 19.2 mm (2.08 x 2.08 x 0.75 in)	
Weight	62.37 g (2.2 oz)	
Cable Length	1.5 m (59 in)	
Connector	USB Type A	
Environmental Data		
Operating Temperature	-40 to +85°C	
Electrical Data		
Center Frequency	1575.42 MHz	
Channels	48 all-in-view tracking	
Sensitivity	-163 dBm	
Voltage	4.5 to 5.5 V dc	
Current	55 mA max.	



VIAVI Solutions

© 2022 VIAVI Solutions Inc.
Product specifications and descriptions
in this document are subject to change
without notice. Patented as described at
viasolutions.com/patents

viasolutions.com

Contact us +1 844 GO VIAVI
To find the VIAVI office nearest you, visit viasolutions.com/contact